

VKSM-Z-20/12-A

I/O-Kabel
I/O cable
Câble I/O

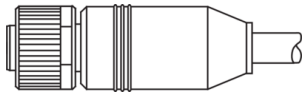

di-soric GmbH & Co. KG
Steinbeisstraße 6
DE-73660 Urbach
Germany
Tel: +49 (0) 7181/9879-0
info@di-soric.com · www.di-soric.com

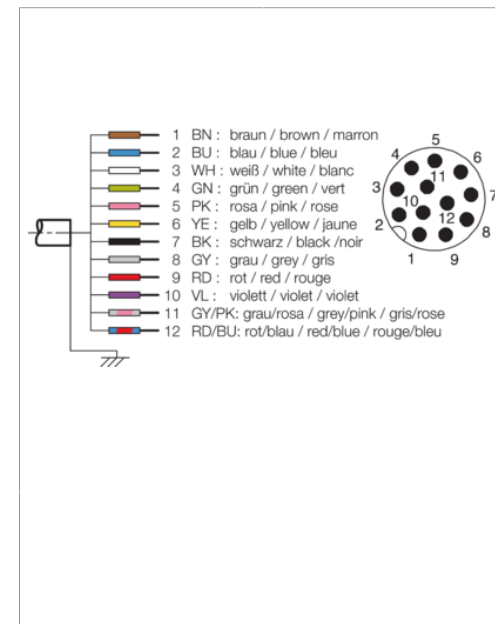
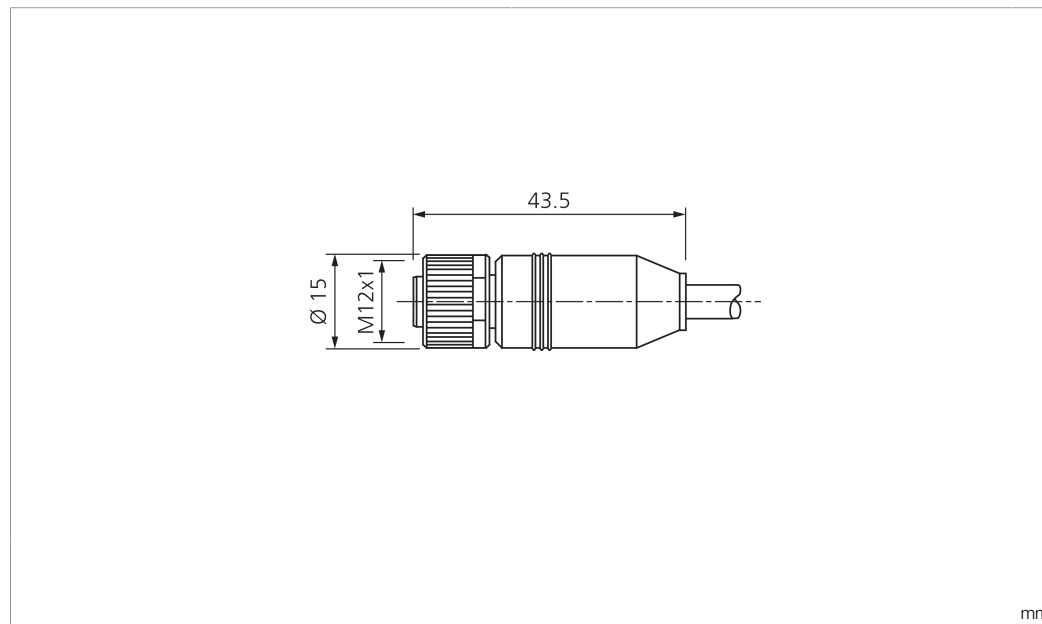

Technische Daten	Technical data	Caractéristiques techniques	
Bauform	Design	Conception	gerade / offenes Kabelende / Straight / open cable end / Extrémité de câble droite/ouverte
Kabellänge	Cable length	Longueur de câble	20000 mm
Betriebsspannung	Service voltage	Tension de service	< 30 V AC/DC
Besonderheiten	Characteristics	Particularités	abgeschirmt, Metallmutter / Shielded, Metal nut / Blindé, Écrou métallique
Material Kabel	Material of cable	Matériau du câble	PUR / Polyurethane / PUR
Umgebungstemperatur Betrieb	Ambient temperature during operation	Température ambiante de fonctionnement	-25 ... +80 °C
Schutzart	Protection type	Indice de protection	IP 67
Anschluss	Connection	Raccordement	Buchse, M12, 12-polig / Socket, M12, 12-pin / Connecteur femelle, M12, 12 pôles

Stand 22.10.24, Änderungen vorbehalten
As of 10/22/24, subject to change
État 22.10.24, sous réserve de modifications



Sicherheitshinweise	Safety instructions	Consignes de sécurité
Allgemeiner Sicherheitshinweis WARNUNG! Kein Sicherheitsbauteil gemäß 2006/42/EG und EN 61496-1 /-2! Darf nicht zum Personenschutz eingesetzt werden! Nichtbeachtung kann zu Tod oder schwersten Verletzungen führen! Nur bestimmungsgemäß verwenden!	General safety notice WARNING! Not a safety component pursuant to 2006/42/EG and EN 61496-1/-2! May not be used for personal protection! Non-compliance can lead to death or serious injuries! Only use as directed!	Consigne de sécurité générale AVERTISSEMENT ! Ce produit n'est pas un composant de sécurité au sens des réglementations 2006/42/CE et NF EN 61496-1/-2 ! Ne pas l'utiliser pour la protection des personnes ! Le non-respect de cette consigne peut entraîner la mort ou des blessures graves ! N'utiliser le produit que selon son utilisation conforme !

VKSM-Z-20/12-A

I/O 电缆

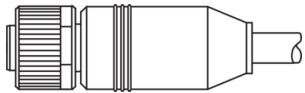

di-soric GmbH & Co. KG
 Steinbeisstraße 6
 DE-73660 Urbach
 Germany
 Tel: +49 (0) 7181/9879-0
 info@di-soric.com · www.di-soric.com

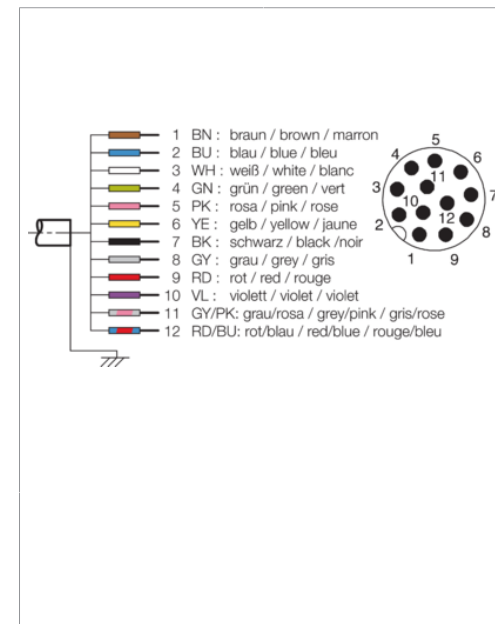
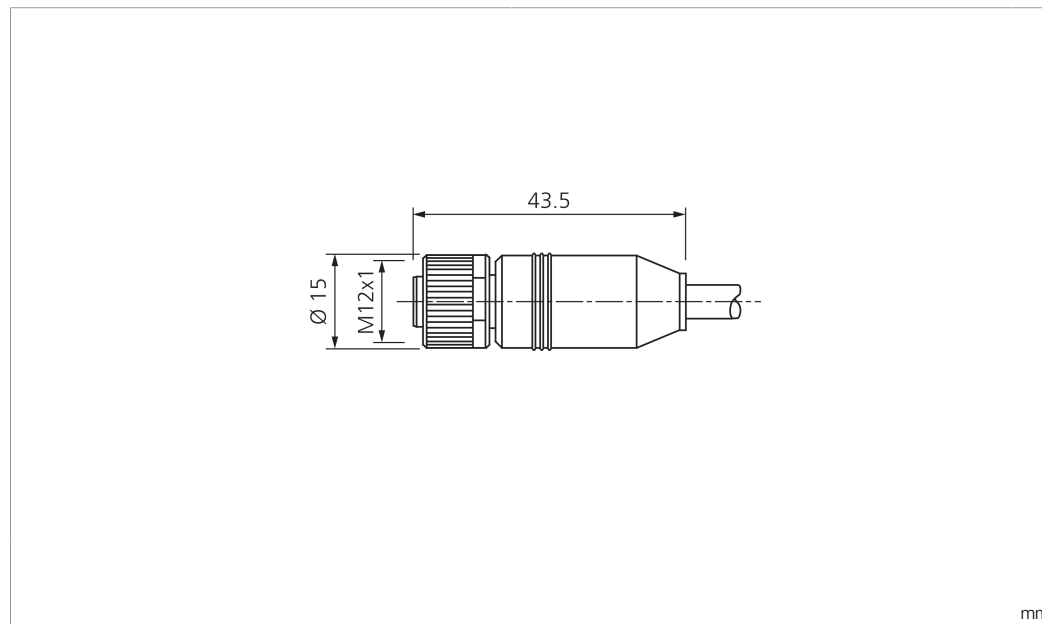

技术数据	
型式	直型 / 裸露的电缆端部
电缆长度	20000 mm
工作电压	< 30 V AC/DC
特点	屏蔽, 金属螺母
电缆材质	PUR
工作环境温度	-25 ... +80 °C
防护等级	IP 67
连接	插口, M12, 12 针

版本 24.10.22, 保留变更权



安全提示
一般安全提示
 警告！没有符合 2006/42/EU 和 EN 61496-1 /-2 标准的安全结构件！不得用于人身安全保护！不遵守规定会导致死亡或重伤危险！仅按规定使用！