

BEK-D70-G2TI-K-BS

Dunkelfeldbeleuchtung
Dark field light
Éclairage en champ sombre

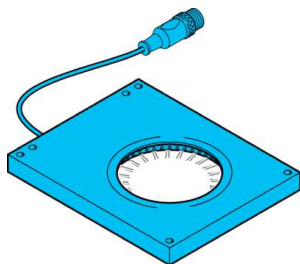

di-soric GmbH & Co. KG
Steinbeisstraße 6
DE-73660 Urbach
Germany
Tel: +49 (0) 7181/9879-0
info@di-soric.com · www.di-soric.com

207441

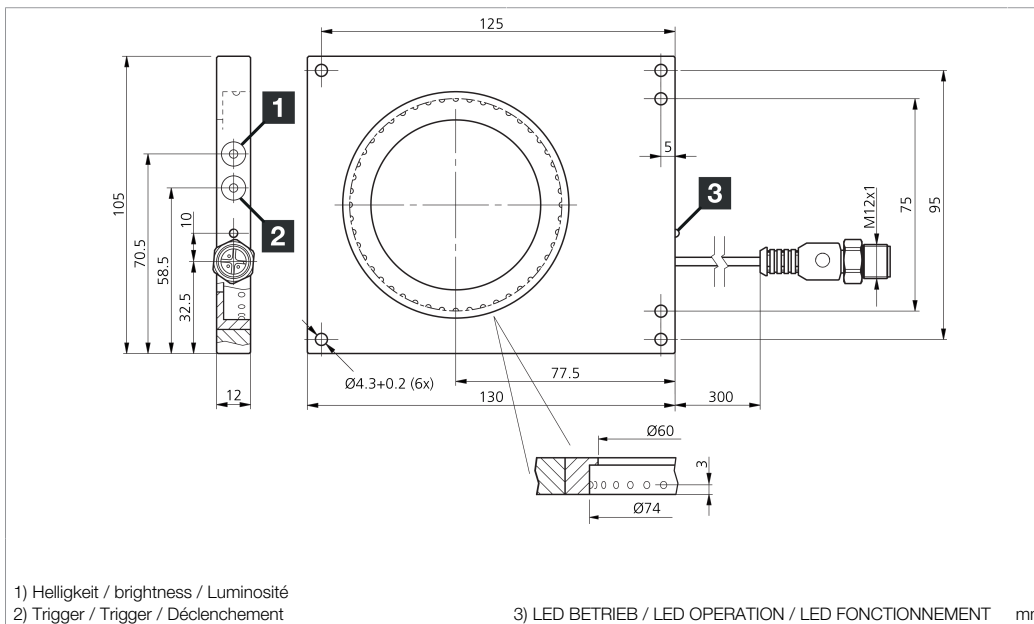

1) Helligkeit / brightness / Luminosité
2) Trigger / Trigger / Déclenchement

3) LED BETRIEB / LED OPERATION / LED FONCTIONNEMENT mm

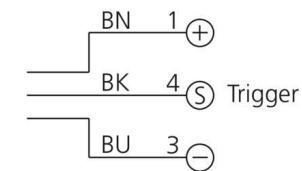

BK : schwarz / black / noir
BN : braun / brown / marron BU : blau / blue / bleu

Technische Daten	Technical data	Caractéristiques techniques	+20°C, 24 V DC
Betriebsspannung	Service voltage	Tension de service	10 ... 35 V DC (Supply Class 2)
Leerlaufstrom (max.)	No-load current (max.)	Courant de marche à vide (max.)	220 mA (24 V DC)
Leistung	Power	Puissance	5,5 W / 24 V DC / 5.5 W / 24 V DC / 5,5 W / 24 V DC
Umgebungstemperatur Betrieb	Ambient temperature during operation	Température ambiante de fonctionnement	0 ... +40 °C
Schutzart	Protection type	Indice de protection	IP 67
Risikogruppe (DIN EN 62471)	Risk group (DIN EN 62471)	Groupe de risque (DIN EN 62471)	Freie Gruppe / Free group / Groupe libre
Schutzklasse	Protection class	Classe de protection	III, Betrieb an Schutzkleinspannung / III, operation on protective low voltage / III, utilisation en très basse tension de sécurité

Stand 16.07.24, Änderungen vorbehalten

As of 07/16/24, subject to change

État 16.07.24, sous réserve de modifications

 Enclosure Type 1 Supply Class 2
NFPA 79 Applications only. For adapters providing field wiring means refer to product information or customer support.

IND. CONT. EQ.
29W7



Sicherheitshinweise



Allgemeiner Sicherheitshinweis

WARNUNG! Kein Sicherheitsbauteil gemäß 2006/42/EG und EN 61496-1 /-2! Darf nicht zum Personenschutz eingesetzt werden! Nichtbeachtung kann zu Tod oder schwersten Verletzungen führen! Nur bestimmungsgemäß verwenden!

Safety instructions



General safety notice

WARNING! Not a safety component pursuant to 2006/42/EG and EN 61496-1/-2! May not be used for personal protection! Non-compliance can lead to death or serious injuries! Only use as directed!

Consignes de sécurité



Consigne de sécurité générale

AVERTISSEMENT ! Ce produit n'est pas un composant de sécurité au sens des réglementations 2006/42/CE et NF EN 61496-1/-2 ! Ne pas l'utiliser pour la protection des personnes ! Le non-respect de cette consigne peut entraîner la mort ou des blessures graves ! N'utiliser le produit que selon son utilisation conforme !

BEK-D70-G2TI-K-BS

暗视野光源

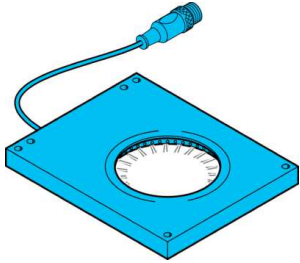

di-soric GmbH & Co. KG
Steinbeisstraße 6
DE-73660 Urbach
Germany
Tel: +49 (0) 7181/9879-0
info@di-soric.com · www.di-soric.com

207441

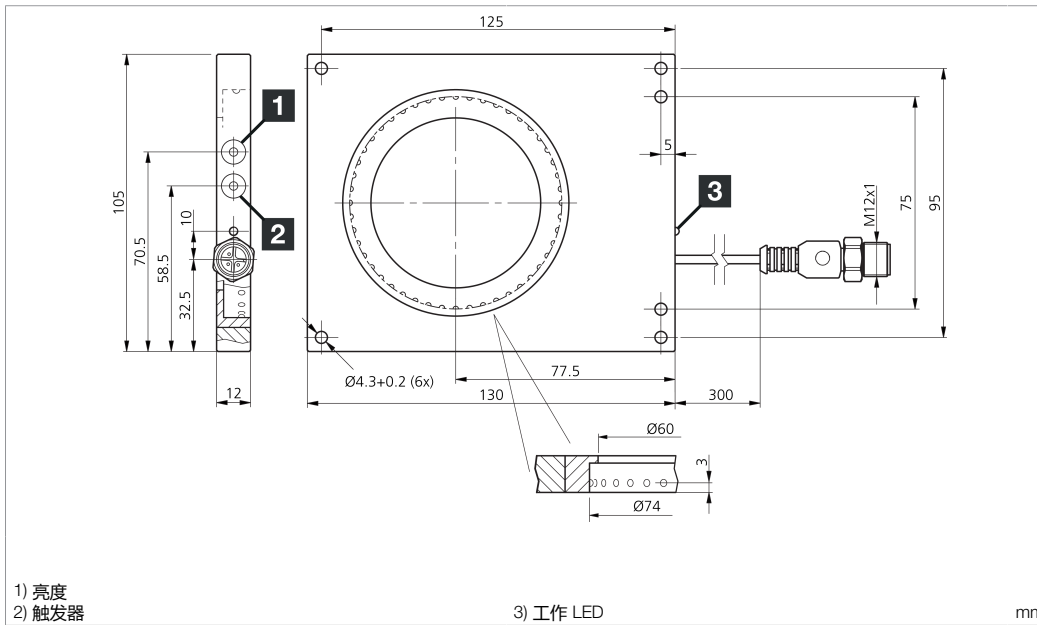

1) 亮度
2) 触发器

3) 工作 LED

mm

BK : 黑色
BN : 棕色

BU : 蓝色

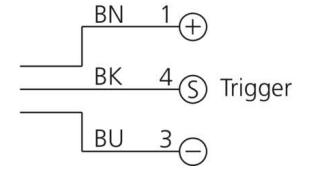

技术数据

工作电压

空载电流 (最大)

功率

工作环境温度

防护等级

风险组 (DIN EN 62471)

防护等级

+20°C, 24 V DC

10 ... 35 V DC (Supply Class 2)

220 mA (24 V DC)

5.5 W / 24 V DC

0 ... +40 °C

IP 67

无危险类

III, 在安全特低电压下工作

版本 24.07.16, 保留变更权

安全提示



一般安全提示

警告！没有符合 2006/42/EU 和 EN 61496-1 /-2 标准的安全结构件！不得用于人身安全保护！不遵守规定会导致死亡或重伤危险！仅按规定使用！



Enclosure Type 1 Supply Class 2
NFPA 79 Applications only. For ad-
apters providing field wiring me-
ans refer to product information or
customer support.



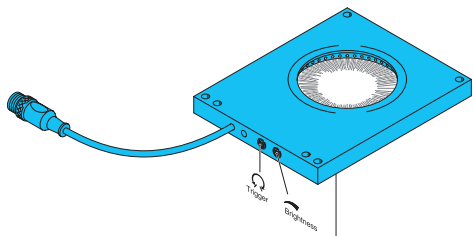



Wärmestau vermeiden!
Avoid heat accumulation!
Évitez l'accumulation de la chaleur !

Dunkelfeldbeleuchtung

-  Nicht dauerhaft in den Lichtstrahl blicken!

-  Diese Beleuchtung erzeugt eine sichtbare oder unsichtbare Strahlung, welche bei dauerhafter Einwirkung schädlich sein kann!

-  Wärmekonvektion gewährleisten!

-  Die Erwärmung der Beleuchtung hat einen direkten Einfluss auf die Alterung/Lebensdauer der Beleuchtungs-LEDs! Je höher die Temperatur, desto stärker die Alterung.

-  - Beleuchtung nicht abdecken
- Beleuchtungsintensität an die Applikation anpassen (überschüssige Lichtstärke vermeiden)
- Dauerlicht reduzieren/vermeiden (Triggerfunktion nutzen)
- Beleuchtung bei längerer Nichtnutzung abschalten

-  Betriebswärme folgendermaßen abführen:
- Montage an eine kühlende Fläche (Maschinenkörper)
- Montage an einen externen Kühlkörper

-  Regelmäßige Reinigung!

- Starke Verschmutzung verhindert den Lichtaustritt und erhöht die Wärmeentwicklung.

Darkfield Light

-  Do not look into the light beam for a prolonged period of time!

-  This light produces radiation which may or may not be visible and prolonged exposure may be harmful!

-  Ensure heat convection!

-  The heating of the light has a direct impact on the ageing/lifetime of the light LEDs! The higher the temperature, the faster the ageing process.

-  - Do not cover the light
- Adapt the light intensity to the application (avoid excessive light intensity)
- Reduce/avoid continuous light (use trigger function)
- Switch off light when it is not being used for longer periods of time

-  Dissipate operating heat as follows:
- Install on a cool surface (machine structure)
- Install on an external cooling element

-  Clean on a regular basis!

- Heavy contamination prevents light emission and increases heat development.

Éclairage en champ sombre

-  Ne pas regarder le rayon lumineux pendant une période de temps prolongée!

-  Cette lumière produit des radiations qui pourraient ou ne pourraient pas être visibles et une exposition prolongée peut être nuisible!

-  Protéger de l'émission de chaleur!

-  La chaleur émise par la lumière a un effet direct sur le vieillissement/la durée de vie des LED! Plus la température s'élève, plus rapide est le processus de vieillissement.s

-  - Ne pas couvrir la lumière
- Adapter l'intensité lumineuse en fonction de la nécessité de l'application (éviter l'excès d'intensité lumineuse)
- Réduire/éviter l'éclairage continu (utiliser la fonction de déclenchement)
- Éteindre l'éclairage lorsqu'il n'est pas utilisé pendant de longues périodes

-  Dissiper la chaleur d'émission comme suit:
- Installer sur une surface froide (structure de la machine)
- Installer sur un élément refroidissant externe

-  Nettoyer régulièrement

- L'encrassement entrave la bonne émission de l'éclairage et accroît l'émission de chaleur.