

IRDBD 4 NSOK-IBS

Induktiver Drahtbruchsensord
 Inductive wire break sensor
 Détecteur de rupture de câbles inductif

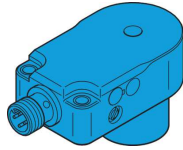

di-soric GmbH & Co. KG
 Steinbeisstraße 6
 DE-73660 Urbach
 Germany
 Tel: +49 (0) 7181/9879-0
 info@di-soric.com · www.di-soric.com

204976

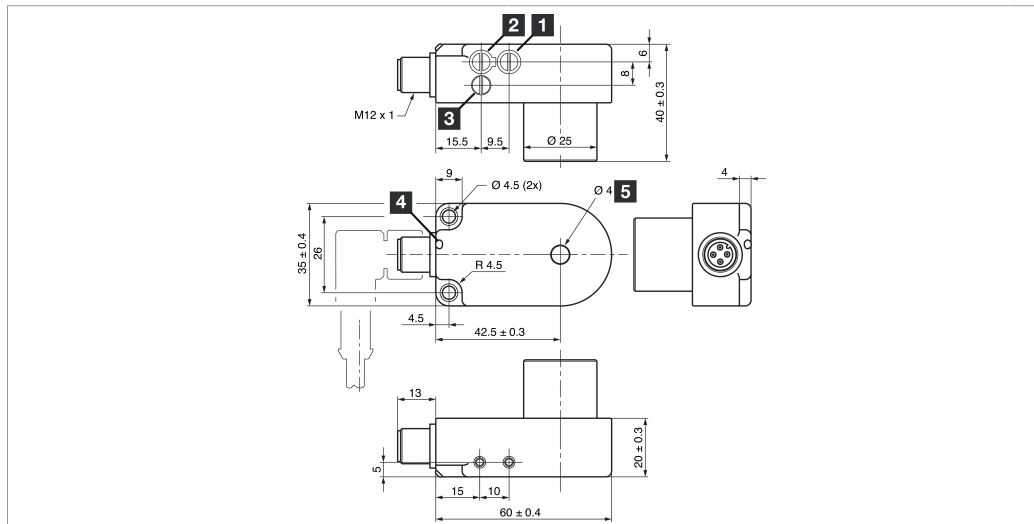

- 1) Empfindlichkeit / sensitivity / Sensibilité
- 2) NO/NC / NO/ NC / NO/NC
- 3) Time / Time / Temps
- 4) LED / LED / LED
- 5) Ring POM mit Keramikeinsatz / Ring POM with ceramic insert / Anneau POM avec insert céramique

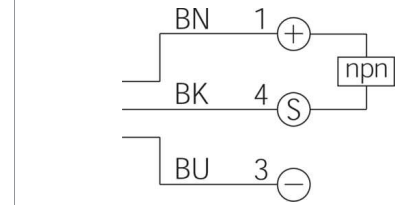

BK : schwarz / black / noir
 BN : braun / brown / marron BU : blau / blue / bleu

Technische Daten	Technical data	Caractéristiques techniques	+20°C, 24 V DC
Innendurchmesser	Internal diameter	Diamètre intérieur	4 mm
Betriebsspannung	Service voltage	Tension de service	10 ... 35 V DC (Supply Class 2)
Schaltausgang	Switching output	Sortie de commutation	npn, 200 mA, NO/NC
Leerlaufstrom (max.)	No-load current (max.)	Courant de marche à vide (max.)	20 mA
Teilgeschwindigkeit (max.)	Speed of parts (max.)	Vitesse de passage des pièces (max.)	35 m/s
Impulsverlängerung	Pulse stretching	Prolongation de l'impulsion	0,1 ... 150 ms / 0,1 ... 150 ms / 0,1 ... 150 ms
Schutzart	Protection type	Indice de protection	IP 67
Umgebungstemperatur Betrieb	Ambient temperature during operation	Température ambiante de fonctionnement	-25 ... +70 °C

Stand 22.10.24, Änderungen vorbehalten
 As of 10/22/24, subject to change
 État 22.10.24, sous réserve de modifications

Enclosure Type 4X (indoor use only), 12, 13 Supply Class 2 NFPA 79 Applications only. For adapters providing field wiring means refer to product information or customer support.

Sicherheitshinweise
Allgemeiner Sicherheitshinweis
 WARNUNG! Kein Sicherheitsbauteil gemäß 2006/42/EG und EN 61496-1 /-2! Darf nicht zum Personenschutz eingesetzt werden! Nichtbeachtung kann zu Tod oder schwersten Verletzungen führen! Nur bestimmungsgemäß verwenden!

Safety instructions
General safety notice
 WARNING! Not a safety component pursuant to 2006/42/EG and EN 61496-1/-2! May not be used for personal protection! Non-compliance can lead to death or serious injuries! Only use as directed!

Consignes de sécurité
Consigne de sécurité générale
 AVERTISSEMENT ! Ce produit n'est pas un composant de sécurité au sens des réglementations 2006/42/CE et NF EN 61496-1/-2 ! Ne pas l'utiliser pour la protection des personnes ! Le non-respect de cette consigne peut entraîner la mort ou des blessures graves ! N'utiliser le produit que selon son utilisation conforme !

IRDBD 4 NSOK-IBS

电感式断线传感器

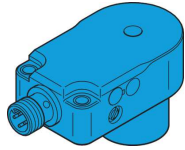

di-soric GmbH & Co. KG
Steinbeisstraße 6
DE-73660 Urbach
Germany
Tel: +49 (0) 7181/9879-0
info@di-soric.com · www.di-soric.com

204976



版本 24.10.22, 保留变更权

 Enclosure Type 4X (indoor use only), 12, 13 Supply Class 2 NFPA 79 Applications only. For adapters providing field wiring means refer to product information or customer support.
IND. CONT. EQ. 29W7

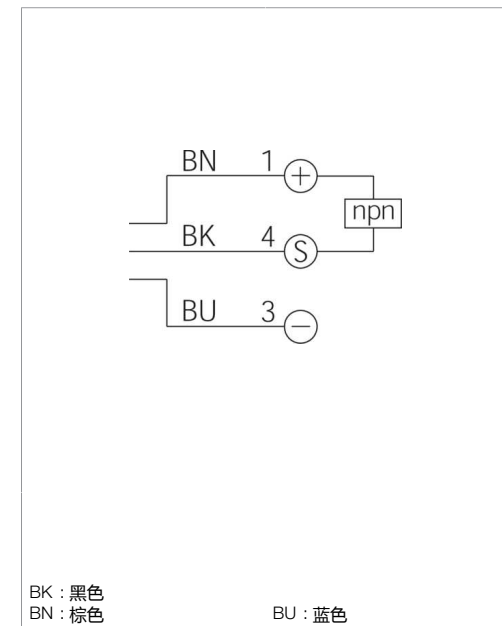
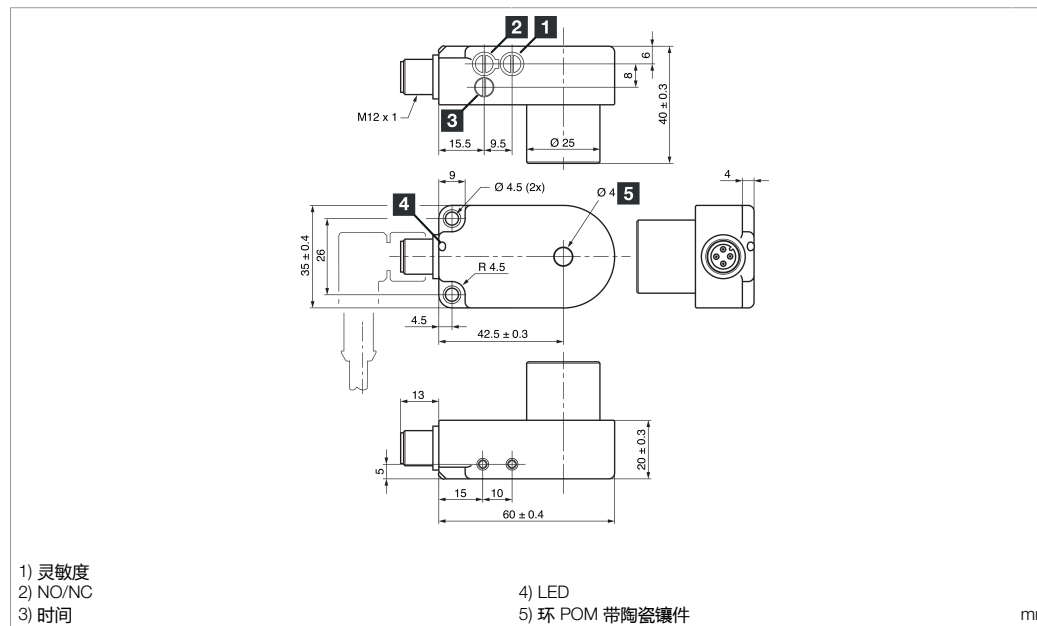

技术数据

内径	4 mm
工作电压	+20°C, 24 V DC
开关输出端	10 ... 35 V DC (Supply Class 2)
空载电流 (最大)	npn, 200 mA, NO/NC
零件速度 (最大)	20 mA
脉冲延展	35 m/s
防护等级	0.1 ... 150 ms
工作环境温度	IP 67
	-25 ... +70 °C

安全提示



一般安全提示

警告！没有符合 2006/42/EU 和 EN 61496-1 /-2 标准的安全结构件！不得用于人身安全保护！不遵守规定会导致死亡或重伤危险！仅按规定使用！

