

AV2-UND/ODER-PS-TS

Anschlussverteiler
 Connection distributor
 Boîtier de raccordement

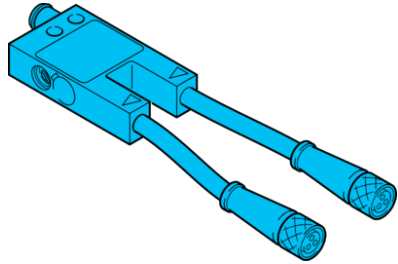

di-soric GmbH & Co. KG
 Steinbeisstraße 6
 DE-73660 Urbach
 Germany
 Tel: +49 (0) 7181/9879-0
 info@di-soric.com · www.di-soric.com

204383



Stand 22.10.24, Änderungen vorbehalten
 As of 10/22/24, subject to change
 État 22.10.24, sous réserve de modifications

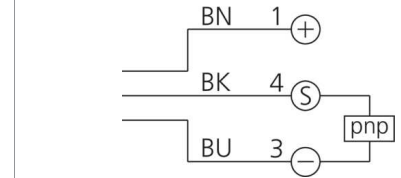
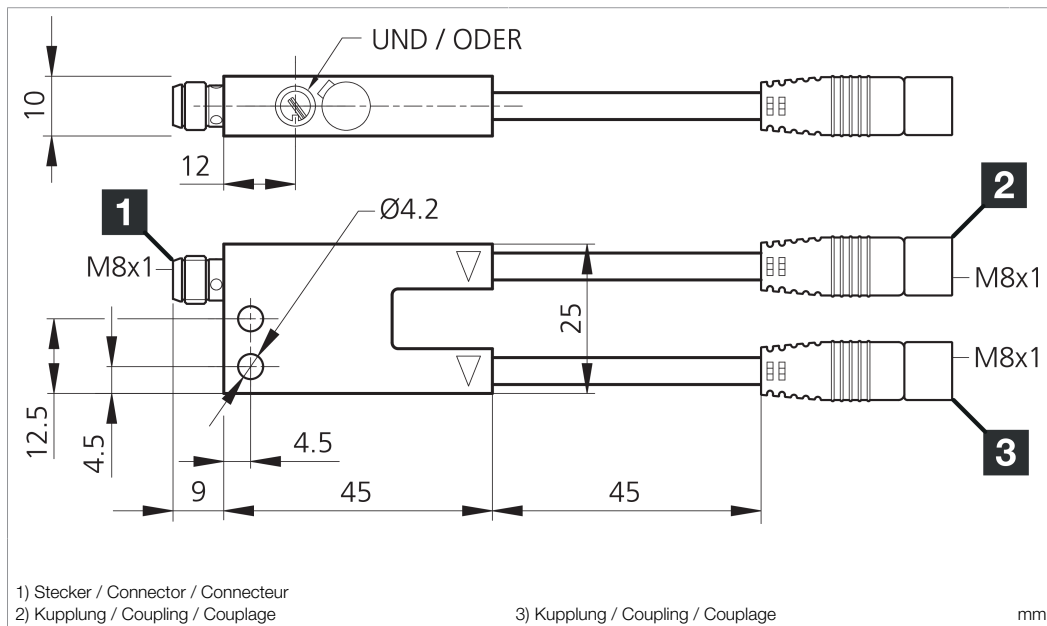

BK : schwarz / black / noir
 BN : braun / brown / marron BU : blau / blue / bleu

Technische Daten	Technical data	Caractéristiques techniques	+20°C, 24 V DC
Auswertung	Evaluation	Évaluation	UND/ODER / AND/OR / ET/OU
Betriebsspannung	Service voltage	Tension de service	10 ... 35 V DC
Leerlaufstrom (max.)	No-load current (max.)	Courant de marche à vide (max.)	14 mA
Funktionsauswahl	Function selection	Sélection de fonctions	200 mA, UND/ODER / 200 mA, AND/OR / 200 mA, ET/OU
Umgebungstemperatur Betrieb	Ambient temperature during operation	Température ambiante de fonctionnement	-25 ... +70 °C
Schutzart	Protection type	Indice de protection	IP 67
Anschluss 1	Connection 1	Raccordement 1	Stecker, M8, 3-polig / Connector, M8, 3-pin / Connecteur, M8, 3 pôles
Anschluss 2	Connection 2	Raccordement 2	Pigtail Buchse M8, 3-polig (2x) / Pigtail Socket M8, 3-pin (2x) / Pigtail Connecteur femelle M8, 3 pôles (2x)

Sicherheitshinweise	Safety instructions	Consignes de sécurité
Allgemeiner Sicherheitshinweis WARNUNG! Kein Sicherheitsbauteil gemäß 2006/42/EG und EN 61496-1 /-2! Darf nicht zum Personenschutz eingesetzt werden! Nichtbeachtung kann zu Tod oder schwersten Verletzungen führen! Nur bestimmungsgemäß verwenden!	General safety notice WARNING! Not a safety component pursuant to 2006/42/EG and EN 61496-1/-2! May not be used for personal protection! Non-compliance can lead to death or serious injuries! Only use as directed!	Consigne de sécurité générale AVERTISSEMENT ! Ce produit n'est pas un composant de sécurité au sens des réglementations 2006/42/CE et NF EN 61496-1/-2 ! Ne pas l'utiliser pour la protection des personnes ! Le non-respect de cette consigne peut entraîner la mort ou des blessures graves ! N'utiliser le produit que selon son utilisation conforme !

AV2_UND/ODER-PS-TS

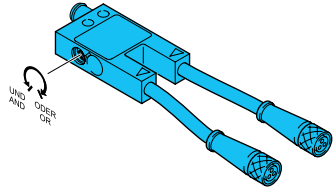

AV2_UND/ODER-PS-IBS

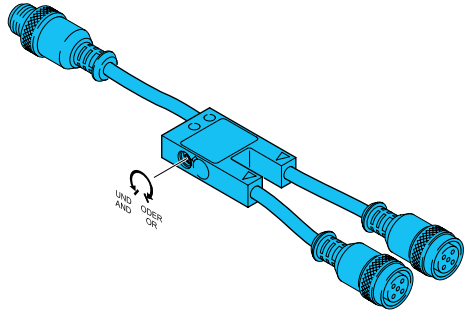

Schaltfunktion:
UND

Switching function:
AND

Fréquence de fonctionnement:
ET

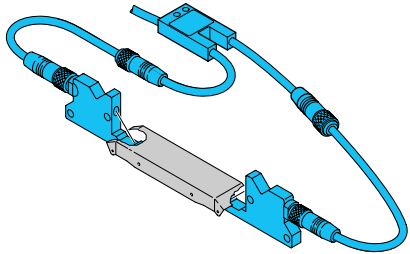

Schaltfunktion:
ODER

Switching function:
OR

Fréquence de fonctionnement:
OU

