

# AV2-UND/ODER-PS-IBS

Anschlussverteiler  
 Connection distributor  
 Boîtier de raccordement

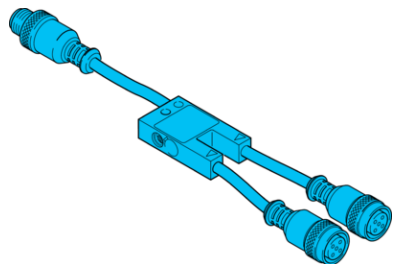

di-soric GmbH & Co. KG  
 Steinbeisstraße 6  
 DE-73660 Urbach  
 Germany  
 Tel: +49 (0) 7181/9879-0  
 info@di-soric.com · www.di-soric.com

204382



Stand 22.10.24, Änderungen vorbehalten  
 As of 10/22/24, subject to change  
 État 22.10.24, sous réserve de modifications

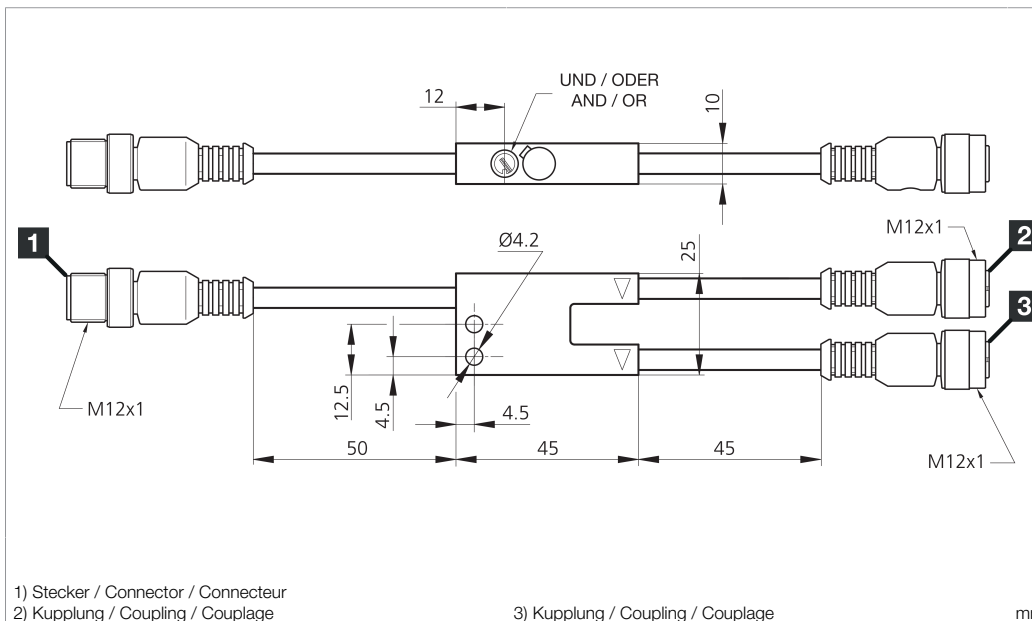

1) Stecker / Connector / Connecteur  
 2) Kupplung / Coupling / Couplage

3) Kupplung / Coupling / Couplage

mm

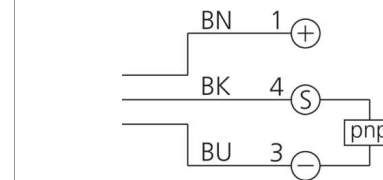

BK : schwarz / black / noir  
 BN : braun / brown / marron BU : blau / blue / bleu

Technische Daten	Technical data	Caractéristiques techniques	+20°C, 24 V DC
Auswertung	Evaluation	Évaluation	UND/ODER / AND/OR / ET/OU
Betriebsspannung	Service voltage	Tension de service	10 ... 35 V DC
Leerlaufstrom (max.)	No-load current (max.)	Courant de marche à vide (max.)	14 mA
Funktionsauswahl	Function selection	Sélection de fonctions	200 mA, UND/ODER / 200 mA, AND/OR / 200 mA, ET/OU
Umgebungstemperatur Betrieb	Ambient temperature during operation	Température ambiante de fonctionnement	-25 ... +70 °C
Schutzart	Protection type	Indice de protection	IP 67
Anschluss 1	Connection 1	Raccordement 1	Pigtail Stecker, M12, 3-polig / Pigtail Connector, M12, 3-pin / Pigtail Connecteur, M12, 3 pôles
Anschluss 2	Connection 2	Raccordement 2	Pigtail Buchse M12, 3-polig (2x) / Pigtail Socket M12, 3-pin (2x) / Pigtail Connecteur femelle M12, 3 pôles (2x)

Sicherheitshinweise	Safety instructions	Consignes de sécurité
<b>Allgemeiner Sicherheitshinweis</b> WARNUNG! Kein Sicherheitsbauteil gemäß 2006/42/EG und EN 61496-1 /-2! Darf nicht zum Personenschutz eingesetzt werden! Nichtbeachtung kann zu Tod oder schwersten Verletzungen führen! Nur bestimmungsgemäß verwenden!	<b>General safety notice</b> WARNING! Not a safety component pursuant to 2006/42/EG and EN 61496-1/-2! May not be used for personal protection! Non-compliance can lead to death or serious injuries! Only use as directed!	<b>Consigne de sécurité générale</b> AVERTISSEMENT ! Ce produit n'est pas un composant de sécurité au sens des réglementations 2006/42/CE et NF EN 61496-1/-2 ! Ne pas l'utiliser pour la protection des personnes ! Le non-respect de cette consigne peut entraîner la mort ou des blessures graves ! N'utiliser le produit que selon son utilisation conforme !

## AV2-UND/ODER-PS-IBS

连接分线器

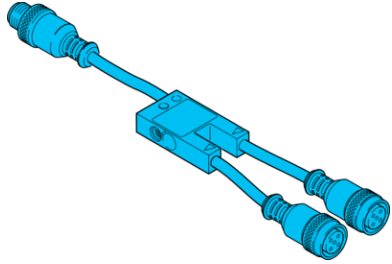

di-soric GmbH & Co. KG  
Steinbeisstraße 6  
DE-73660 Urbach  
Germany  
Tel: +49 (0) 7181/9879-0  
info@di-soric.com · www.di-soric.com

204382



版本 24.10.22, 保留变更权

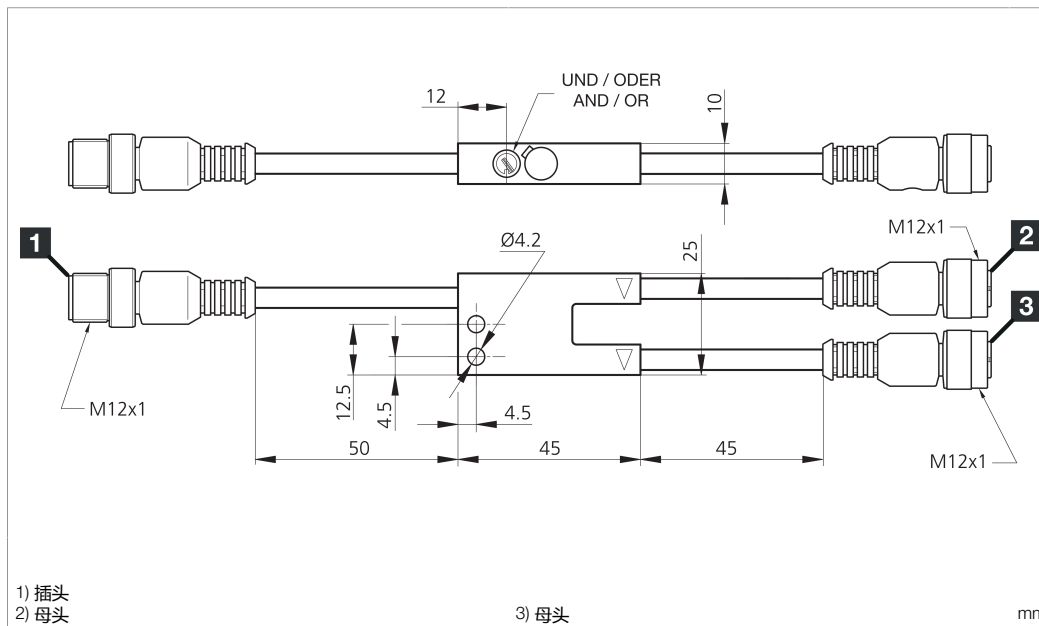

1) 插头  
2) 母头

3) 母头

mm

BK : 黑色  
BN : 棕色

BU : 蓝色

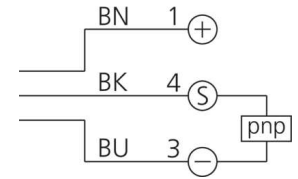

### 技术数据

评估

工作电压

空载电流 (最大)

功能选择

工作环境温度

防护等级

连接 1

连接 2

+20°C, 24 V DC

AND/OR

10 ... 35 V DC

14 mA

200 mA, AND/OR

-25 ... +70 °C

IP 67

电缆/插头 插头, M12, 3 针

电缆/插头 插口 M12, 3 针 (2x)

### 安全提示



#### 一般安全提示

警告！没有符合 2006/42/EU 和 EN 61496-1 /-2 标准的安全结构件！不得用于人身安全保护！不遵守规定会导致死亡或重伤危险！仅按规定使用！

AV2\_UND/ODER-PS-TS

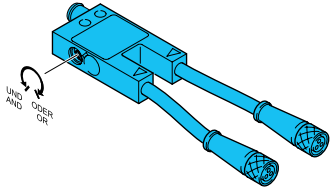

AV2\_UND/ODER-PS-IBS

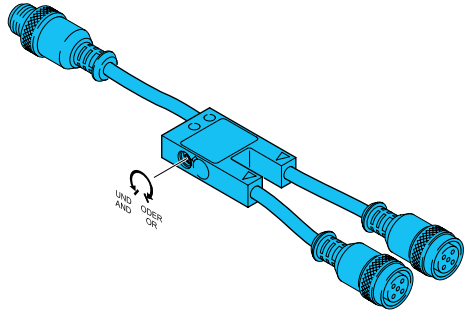

Schaltfunktion:  
**UND**

Switching function:  
**AND**

Fréquence de fonctionnement:  
**ET**

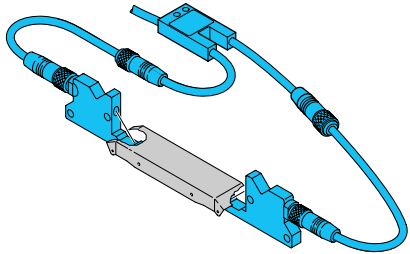

Schaltfunktion:  
**ODER**

Switching function:  
**OR**

Fréquence de fonctionnement:  
**OU**

