

# VKHM-Z/VSM-Z/U

Funktionsadapter  
Function adapters  
Adaptateurs multifonctions

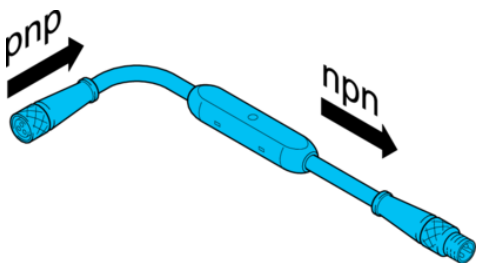

di-soric GmbH & Co. KG  
Steinbeisstraße 6  
DE-73660 Urbach  
Germany  
Tel: +49 (0) 7181/9879-0  
info@di-soric.com · www.di-soric.com

202852

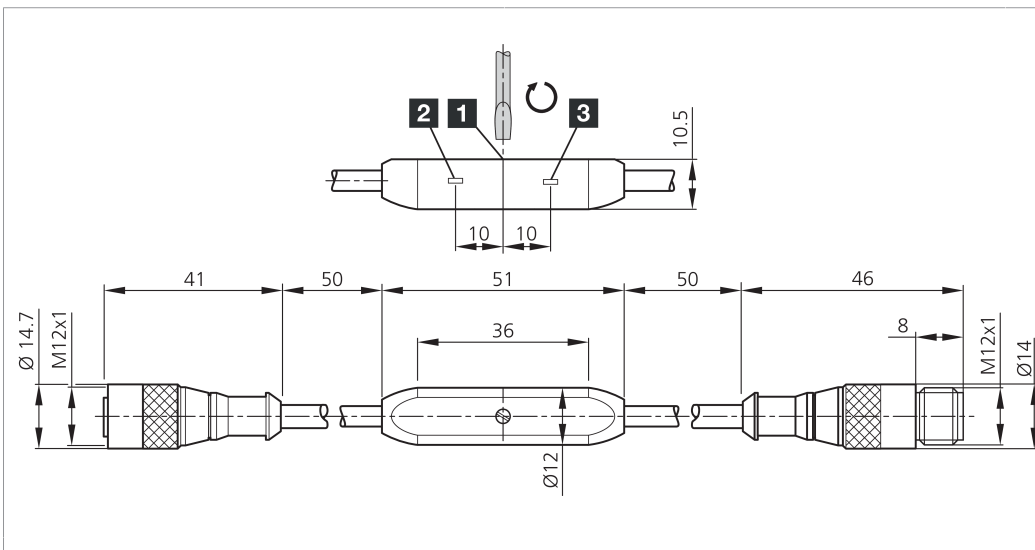

1) Potentiometer (nur ...TSM-Z/T) / Potentiometer (only ...TSM-Z/T) / Potentiomètre (uniquement ...TSM-Z/T)  
 2) LED STATUS / LED STATUS / LED STATUT  
 3) LED SCHALTAUSGANG / LED SWITCHING OUTPUT / LED SORTIE DE COMMUTATION

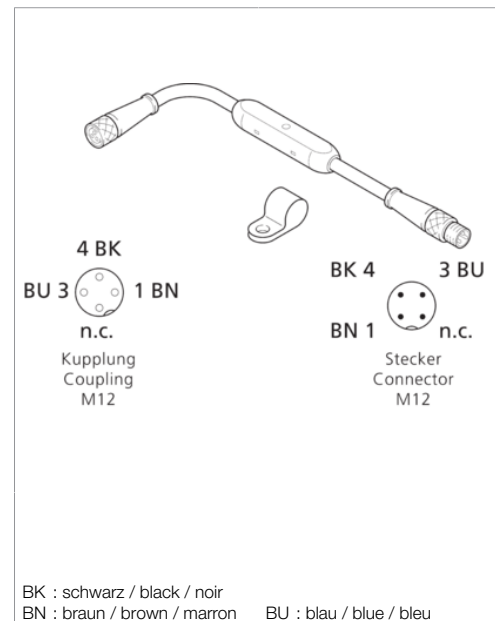

Technische Daten	Technical data	Caractéristiques techniques	+20°C, 24 V DC
Auswertung	Evaluation	Évaluation	pnp -> npn Umsetzer / pnp -> npn converter / Convertisseur pnp -> npn
Betriebsspannung	Service voltage	Tension de service	10 ... 35 V DC
Leerlaufstrom (max.)	No-load current (max.)	Courant de marche à vide (max.)	20 mA
Funktionsauswahl	Function selection	Sélection de fonctions	pnp
Schaltfrequenz	Switching frequency	Fréquence de commutation	5000 Hz
Umgebungstemperatur Betrieb	Ambient temperature during operation	Température ambiante de fonctionnement	-20 ... +70 °C
Schutzart	Protection type	Indice de protection	IP 67
Anschluss 1	Connection 1	Raccordement 1	Pigtail Kupplung, M12, 3-polig / Pigtail Coupling, M12, 3-pin / Pigtail Couplage, M12, 3 pôles
Anschluss 2	Connection 2	Raccordement 2	Pigtail Stecker M12, 3-polig / Pigtail Connector M12, 3-pin / Pigtail Connecteur M12, 3 pôles

Stand 22.10.24, Änderungen vorbehalten  
As of 10/22/24, subject to change  
État 22.10.24, sous réserve de modifications

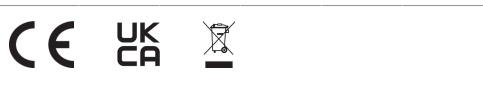

Sicherheitshinweise	Safety instructions	Consignes de sécurité
<b>Allgemeiner Sicherheitshinweis</b> WARNUNG! Kein Sicherheitsbauteil gemäß 2006/42/EG und EN 61496-1 /-2! Darf nicht zum Personenschutz eingesetzt werden! Nichtbeachtung kann zu Tod oder schwersten Verletzungen führen! Nur bestimmungsgemäß verwenden!	<b>General safety notice</b> WARNING! Not a safety component pursuant to 2006/42/EG and EN 61496-1/-2! May not be used for personal protection! Non-compliance can lead to death or serious injuries! Only use as directed!	<b>Consigne de sécurité générale</b> AVERTISSEMENT ! Ce produit n'est pas un composant de sécurité au sens des réglementations 2006/42/CE et NF EN 61496-1/-2 ! Ne pas l'utiliser pour la protection des personnes ! Le non-respect de cette consigne peut entraîner la mort ou des blessures graves ! N'utiliser le produit que selon son utilisation conforme !

## VKHM-Z/VSM-Z/U

多功能转换器

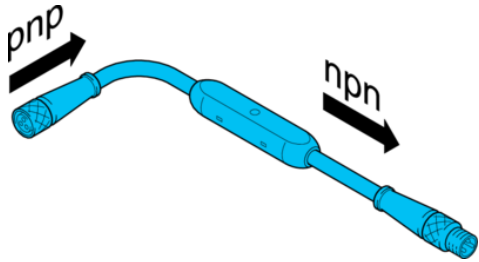

di-soric GmbH & Co. KG  
 Steinbeisstraße 6  
 DE-73660 Urbach  
 Germany  
 Tel: +49 (0) 7181/9879-0  
 info@di-soric.com · www.di-soric.com

202852



版本 24.10.22, 保留变更权

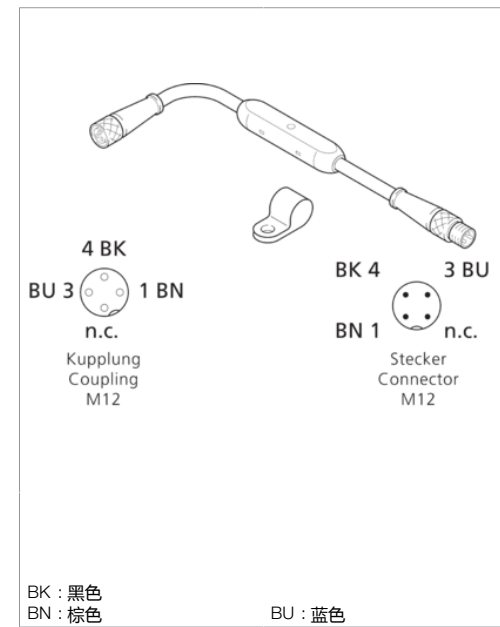
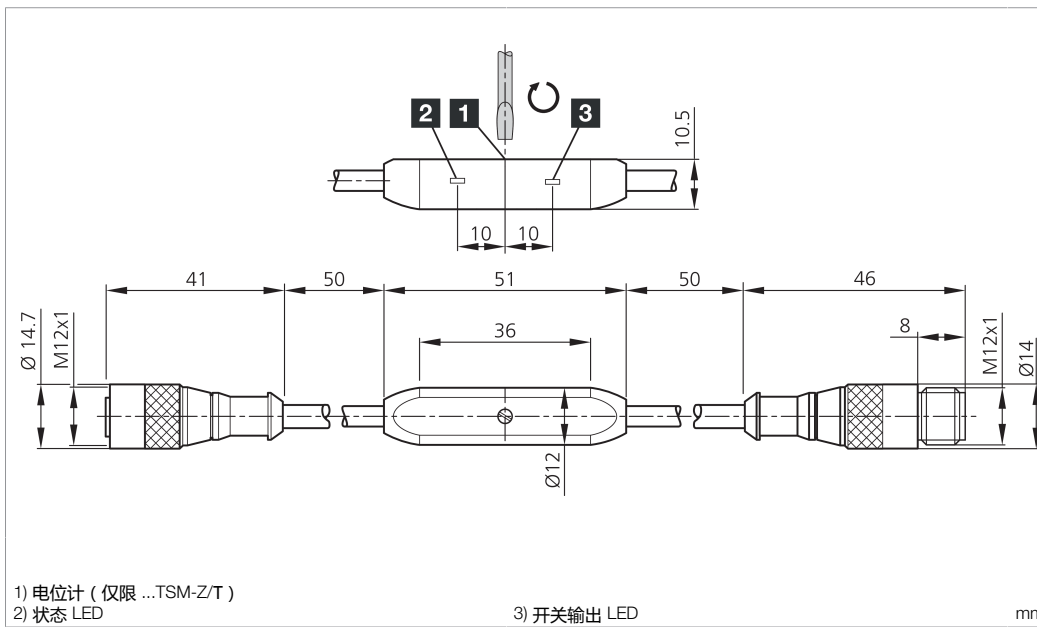

<b>技术数据</b>	<b>+20°C, 24 V DC</b>
评估	pnp -> npn 转换器
工作电压	10 ... 35 V DC
空载电流 (最大)	20 mA
功能选择	pnp
开关频率	5000 Hz
工作环境温度	-20 ... +70 °C
防护等级	IP 67
连接 1	电缆/插头 母头, M12, 3 针
连接 2	电缆/插头 插头 M12, 3 针

**安全提示**

**一般安全提示**  
 警告！没有符合 2006/42/EU 和 EN 61496-1 /-2 标准的安全结构件！不得用于人身安全保护！不遵守规定会导致死亡或重伤危险！仅按规定使用！