

LLGT 081 M 25 IUG8-B8

Linienlaser-Gabellichtschranke
Line laser fork light barrier
Fourche optique laser linéique

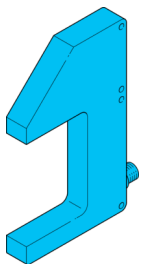

di-soric GmbH & Co. KG
Steinbeisstraße 6
DE-73660 Urbach
Germany
Tel: +49 (0) 7181/9879-0
info@di-soric.com · www.di-soric.com

207338

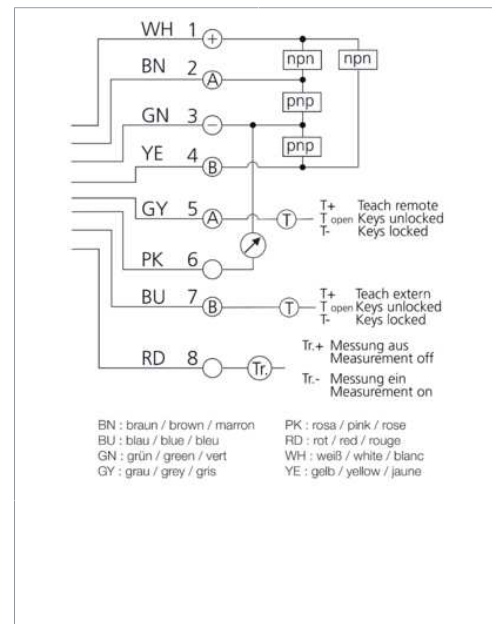
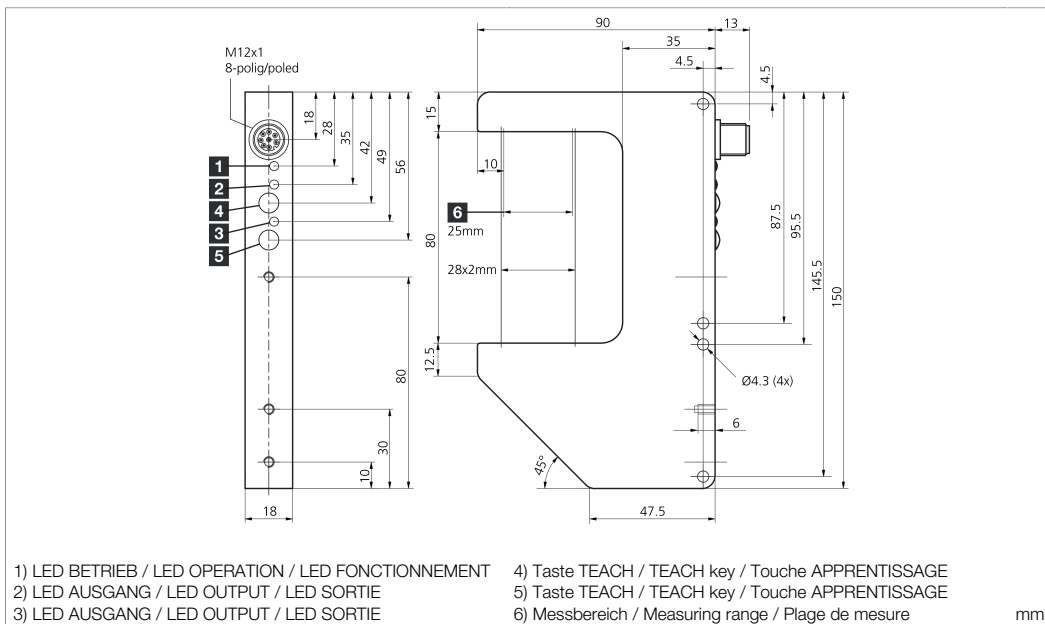

Technische Daten	Technical data	Caractéristiques techniques	+20°C, 24 V DC
Sendelichtquelle	Transmitter light source	Source lumineuse émetteur	Laser
Lichtfarbe	Light color	Couleur de lumière	Rot / 650 nm / Red / 650 nm / Rouge / 650 nm
Betriebsspannung	Service voltage	Tension de service	18 ... 30 V DC
Leerlaufstrom (max.)	No-load current (max.)	Courant de marche à vide (max.)	70 mA (24 V DC)
Schaltausgang	Switching output	Sortie de commutation	Gegentakt, 150 mA, NO/NC / Push-pull, 150 mA, NO/NC / Push-pull, 150 mA, NO/NC
Analogausgang Spannung	Analog output voltage	Sortie analogique tension	0 ... 10 V
Analogausgang Strom	Analog output current	Sortie analogique courant	4 ... 20 mA
Zulässige Impedanz	Permissible impedance	Impédance admissible	> 1 kΩ, < 0,5 kΩ
Umgebungstemperatur Betrieb	Ambient temperature during operation	Température ambiante de fonctionnement	+5 ... +45 °C
Schutzart	Protection type	Indice de protection	IP 67

Stand 20.11.24, Änderungen vorbehalten
As of 11/20/24, subject to change
État 20.11.24, sous réserve de modifications

Funktion / Function / Fonction

CE UK CA I

Sicherheitshinweise	Safety instructions	Consignes de sécurité
<p>Laserklasse 1 Produkt IEC 60825-1:2014 / EN 60825-1:2014+A11:2021 Entspricht 21 CFR 1040.10, mit Ausnahme der Konformität mit IEC 60825-1 Ed. 3., wie in Laser Notice Nr. 56 vom 8. Mai 2019 beschrieben.</p>	<p>Class 1 Laser Product IEC 60825-1:2014 / EN 60825-1:2014+A11:2021 Complies with 21 CFR 1040.10 except for conformance with IEC 60825-1 Ed. 3., as described in Laser Notice No. 56, dated May 8, 2019.</p>	<p>Produit laser de classe 1 IEC 60825-1:2014 / EN 60825-1:2014+A11:2021 Conforme à la norme 21 CFR 1040.10, à l'exception de la conformité à la norme IEC 60825-1 Ed. 3., comme décrit dans l'avis Laser Notice n° 56, daté du 8 mai 2019.</p>
<p>Laserklasse 1 Sicherheitshinweis Nicht bestimmungsgemäßer Gebrauch kann zur Aussetzung schädlicher Laserstrahlung führen. Unfallverhütungsvorschriften und Laserklasse beachten. Diese Geräte sind nicht zulässig für Sicherheitsanwendungen, insbesondere bei denen die Sicherheit von Personen von der Gerätefunktion abhängig ist. Der Einsatz der Geräte muss durch Fachpersonal erfolgen.</p>	<p>Class 1 Laser Safety instructions Improper use may result in hazardous radiation exposure. Pay attention to accident prevention rules and laser class. The instruments are not to be used for safety applications, in particular applications in which safety of persons depends on proper operation of the instruments. These instruments shall exclusively be used by qualified personnel.</p>	<p>Classe laser 1 Instructions de sécurité Une utilisation inadaptée peut engendrer une exposition dangereuse aux radiations. Respecter les instructions de sécurité et les classes des lasers. La mise en œuvre de ces appareils doit être effectuée par du personnel qualifié. Ils ne doivent pas être utilisés pour des applications dans lesquelles la sécurité des personnes dépend du bon fonctionnement du matériel.</p>

LLGT 081 M 25 IUG8-B8

线激光槽型光电开关

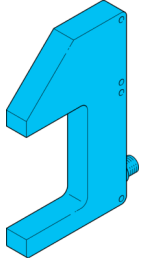

di-soric GmbH & Co. KG
Steinbeisstraße 6
DE-73660 Urbach
Germany
Tel: +49 (0) 7181/9879-0
info@di-soric.com · www.di-soric.com

207338

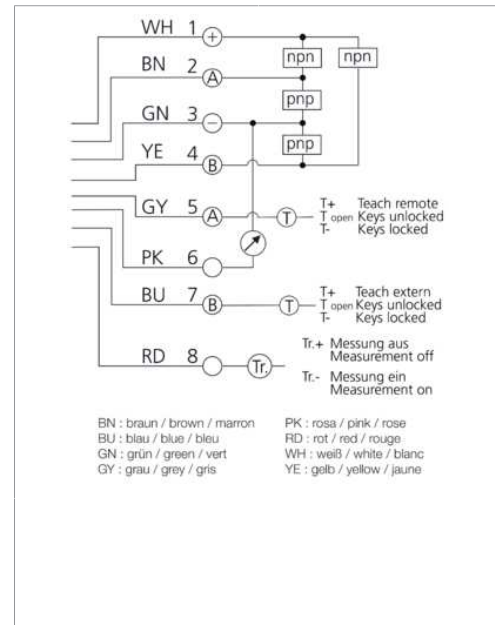
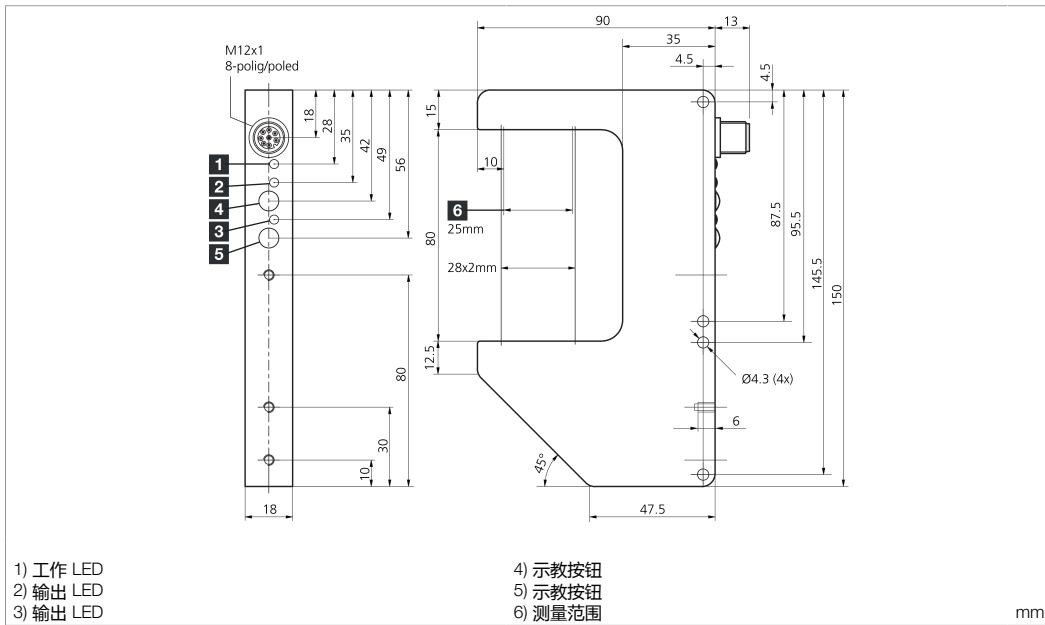

技术数据

发射光源

光色

工作电压

空载电流 (最大)

开关输出端

模拟量输出端, 电压

模拟量输出端, 电流

允许阻抗

工作环境温度

防护等级

+20°C, 24 V DC

激光

红色 / 650 nm

18 ... 30 V DC

70 mA (24 V DC)

推挽式, 150 mA, NO/NC

0 ... 10 V

4 ... 20 mA

> 1 kΩ, < 0,5 kΩ

+5 ... +45 °C

IP 67

版本 24.11.20, 保留变更权

功能

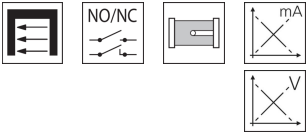

安全提示

激光等级 1 产品
IEC 60825-1:2014 / EN 60825-1:2014+A11:2021
符合 21 CFR 1040.10, 但不符合 IEC 60825-1 Ed. 3., 如 2019 年 5 月 8 日发布的激光通知第 56 号所述。

激光等级 1
安全提示
不按规定使用会导致暴露在有害的激光辐射中。遵守事故预防条例和激光等级。此类设备不允许用于安全应用, 尤其是那些人身安全取决于设备功能的应用。只能由专业人士使用设备。

Inhaltsverzeichnis

Seite

contents!

Page

Allgemeine Hinweise

2

General notes

2

Analogausgang Grundeinstellungen

3

Analog output Basic settings

7

Analogausgang Applikationsbeispiele

4

Analog output application examples

8

Schaltausgang A/B Grundeinstellungen

5

Switching output A / B Basic settings

9

Schaltausgang A/B Applikationsbeispiele

6

Switching output A/B Application examples

10

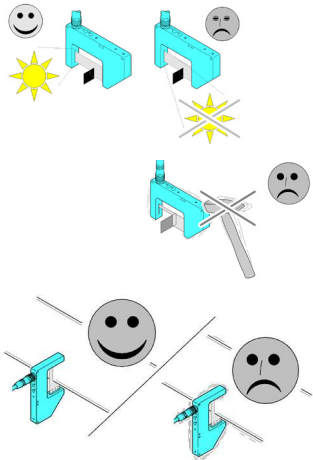

Allgemeine Hinweise!

Fremdlicht:

Starkes Fremdlicht im Erfassungsbereich des Empfängers vermeiden.

Mechanische Belastungen:

Der Sensor ist gegen mechanische Belastungen z.B. Stöße und Schläge zu schützen.

Der Sensor darf in beliebiger Einbaulage montiert werden, hierbei ist eine erschütterungsfreie und schwingungsdämpfende Montage zu beachten.

General notes!

Ambient light:

Avoid strong ambient shining into the detection range of the receiver.

Mechanical loads:

The sensor has to be protected against mechanical stress for example shocks and impacts.

The sensor can be mounted in any position, however a vibration-free or vibration-dampening assembly must be observed.

Montage:

Bei Montage zwei Scheiben zwischen Sensor und Sensorhalter einsetzen.

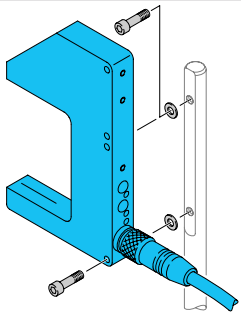

Mounting:

During assembly two washers need to be placed between sensor and mounting bracket.

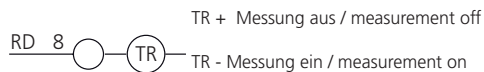

Hinweis!

-Analoge Auswertung erfolgt ausschließlich wenn PIN 8 auf minus (⊖)!
-TR offen oder +Ub: Messung angehalten!

Note!

-Analogue evaluation only when PIN 8 on GND (⊖)!
-TR n.c. or TR on +Ub: Measurement stopped!

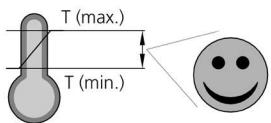

Temperaturbereich:

Der Betrieb außerhalb dem angegebenen Temperaturbereich ist nicht zulässig.

Temperature range:

Operation outside the specified temperature range is not allowed.

Teachbereiche:

Teach areas:

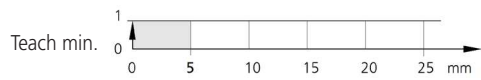

Analogausgang:
Teachbereich >5 mm / < 25 mm

Analog output:
Teach area >5 mm / < 25 mm

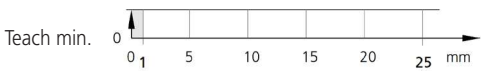
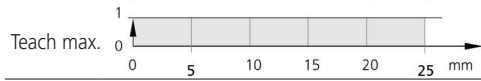

Schaltausgang:
Teachbereich >1 mm / < 25 mm

Switching output:
Teach area >1 mm / < 25 mm

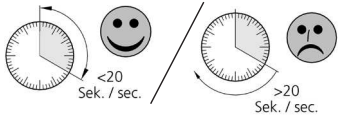
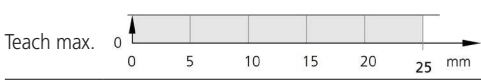







Zeitlimit Schritt 1 / 2:
Zur Speicherung der Werte muss das Einlesen der Schritte 1 und 2 innerhalb 20 Sek. erfolgen.

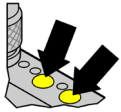
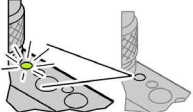
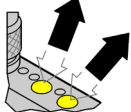
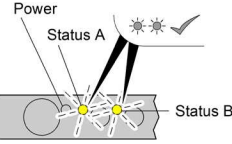
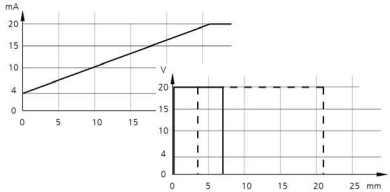
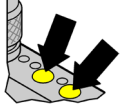
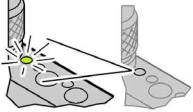
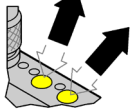

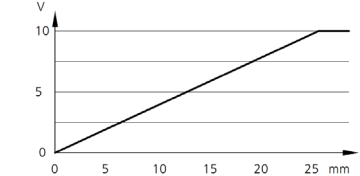
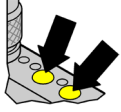
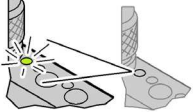
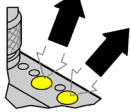
Time limit step 1 / 2:
For saving the values step 1 and step 2 must be taught within 20 sec.

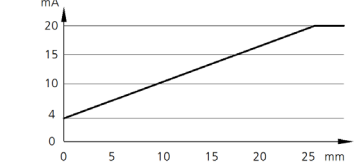
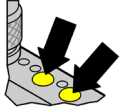
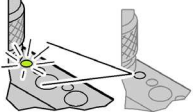
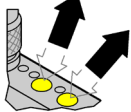
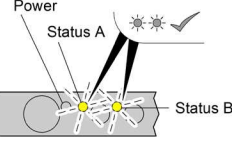
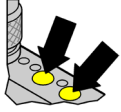
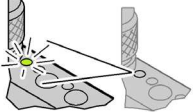
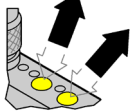
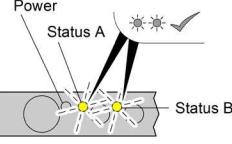
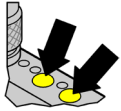
Pflegehinweis:
Die optische Scheiben sind mit einem weichen, staubfreien Tuch zu reinigen.

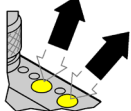
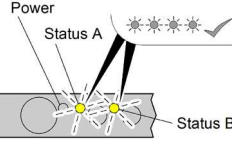
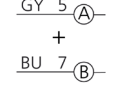
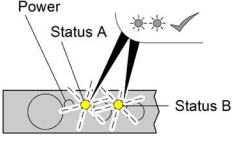
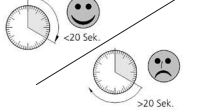
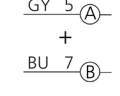
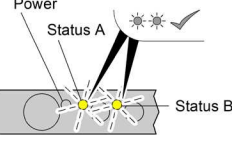



Care instructions:
The optical plate should be cleaned with a soft, lint-free cloth.

Pos.	Analogausgang Grundeinstellungen	Aktion 1	Hinweis 1	Hinweis 2	Aktion 2	Ergebnis LED	Ergebnis Diagramm	Beschreibung Ergebnis
A1	Wiederherstellung der Werkseinstellung	Beide Tasten > 10 Sek. drücken und halten 	Power LED erlischt sofort 	Beide LEDs: >2 Sek. an; >6 Sek. aus; >10 Sek. blinken	Beide Tasten loslassen 	Beide LEDs blinken 2x 		keine Bedeckung 4 mA, volle Bedeckung 20 mA Out A: 2,8...28% (High) Out B: 14...84% (High)
A2	Umschaltung des Analogausgangs 4...20 mA / 0...10VDC	Beide Tasten > 6 Sek. drücken und halten 	Power LED erlischt sofort 	Beide LEDs gehen nach >2 Sek. an und nach >6 Sek. wieder aus	Beide Tasten loslassen 	Beide LEDs blinken schnell im Wechsel 2x Status A Status B 		Ausgangssignal 0...10 V
A3	Umschaltung des Analogausgangs 0...10VDC / 4...20 mA	Beide Tasten > 6 Sek. drücken und halten 	Power LED erlischt sofort 	Beide LEDs gehen nach >6 Sek. aus	Beide Tasten loslassen 	Beide LEDs blinken langsam im Wechsel 2x Status A Status B 		Ausgangssignal 4...20 mA
A4	Teachvorgang Analog einleiten = Schritt 1 einlernen	Beide Tasten > 2 Sek. drücken und halten 	Power LED erlischt sofort 	Beide LEDs gehen nach >2 Sek. an	Beide Tasten loslassen 	Beide LEDs blinken 20 Sek. Power Status A Status B 		Zum Ändern der Werte muss innerhalb 20 Sek. Schritt 2 erfolgen, ansonsten bleiben die alten Werte erhalten!
A4.1	Teachbereich > 5 mm < 25 mm Teachvorgang Analog innerhalb 20 Sek. fertig stellen = Schritt 2 einlernen	Beide Tasten < 2 Sek. drücken und halten 	Power LED erlischt sofort 	Beide LEDs gehen sofort aus	Beide Tasten loslassen 	Beide LEDs blinken 2x Power Status A Status B 		2-maliges Blinken signalisiert den erfolgreichen Teachvorgang
A4.2	Teachbereich < 5 mm Teachbereich zu klein Teachvorgang Analog innerhalb 20 Sek. fertig stellen = Schritt 2 einlernen	Beide Tasten < 2 Sek. drücken und halten 	Power LED erlischt sofort 	Beide LEDs gehen sofort aus	Beide Tasten loslassen 	Beide LEDs blinken 4x Power Status A Status B 		4-maliges Blinken signalisiert einen zu kleinen Analogbereich, der Analogbereich wird auf ±2,5 mm um Schritt 1 gelegt
A5	Teachvorgang mit externen Leitungen: 2xSignal > 0,1 Sek. an beiden Eingängen für Schritt 1 und Schritt 2	Pin 5+7 > 0,1 Sek. auf +U _b (>6V) legen 	20 Sek. blinken beider LEDs Power Status A Status B 	Innerhalb von 20 Sek. muss der zweite Teachvorgang erfolgen! 	Pin 5+7 > 0,1 Sek. auf +U _b (>6V) legen 	Beide LEDs blinken 2x Power Status A Status B 		2-maliges Blinken signalisiert den erfolgreichen Teachvorgang Zum Ändern der Werte muss innerhalb 20 Sek. Schritt 2 erfolgen, ansonsten bleiben die alten Werte erhalten!

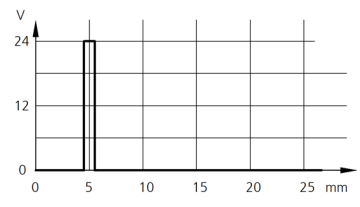
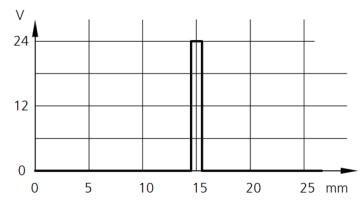
Pos.	Analogausgang Applikationsbeispiele	Schritt 1:	per Tasten	per Fernteach	Schritt 2:	per Tasten	per Fernteach	Ergebnis LED	Ergebnis Diagramm	Beschreibung Ergebnis
AP1	Messbereich bei steigender Kennlinie definieren: Zone frei = 4 mA Zone kpl. bedeckt = 20 mA		Teach-Tasten A+B > 2 Sek. betätigen	Pin 5+7 > 0,1 Sek. auf +U _b (>6V) legen GY 5 (A) + BU 7 (B)		Teach-Tasten A+B > 2 Sek. betätigen	Pin 5+7 > 0,1 Sek. auf +U _b (>6V) legen GY 5 (A) + BU 7 (B)	Beide LEDs blinken 2x 		Zone frei = 4 mA Zone kpl. bedeckt = 20 mA
AP2	Messbereich bei fallender (invertierter) Kennlinie definieren: Zone frei = 20 mA Zone kpl. bedeckt = 4 mA		Teach-Tasten A+B > 2 Sek. betätigen	Pin 5+7 > 0,1 Sek. auf +U _b (>6V) legen GY 5 (A) + BU 7 (B)		Teach-Tasten A+B > 2 Sek. betätigen	Pin 5+7 > 0,1 Sek. auf +U _b (>6V) legen GY 5 (A) + BU 7 (B)	Beide LEDs blinken 2x 		Zone frei = 20 mA Zone kpl. bedeckt = 4 mA
AP3	Eingeengter Messbereich bei steigender Kennlinie definieren: 5 mm bedeckt = 4 mA 15 mm bedeckt = 20 mA		Teach-Tasten A+B > 2 Sek. betätigen	Pin 5+7 > 0,1 Sek. auf +U _b (>6V) legen GY 5 (A) + BU 7 (B)		Teach-Tasten A+B > 2 Sek. betätigen	Pin 5+7 > 0,1 Sek. auf +U _b (>6V) legen GY 5 (A) + BU 7 (B)	Beide LEDs blinken 2x 		Der Analogausgang sinkt bei unter 5mm auf 3,2 mA oder steigt über 15mm auf 20,8 mA und springt bei Überschreitung dieser Grenzen auf 21,6 mA
AP4	Eingeengter Messbereich bei fallender (invertierter) Kennlinie definieren: 15 mm bedeckt = 4 mA 5 mm bedeckt = 20 mA		Teach-Tasten A+B > 2 Sek. betätigen	Pin 5+7 > 0,1 Sek. auf +U _b (>6V) legen GY 5 (A) + BU 7 (B)		Teach-Tasten A+B > 2 Sek. betätigen	Pin 5+7 > 0,1 Sek. auf +U _b (>6V) legen GY 5 (A) + BU 7 (B)	Beide LEDs blinken 2x 		Der Analogausgang steigt bei unter 5mm auf 20,8 mA oder sinkt über 15mm auf 3,2 mA und springt bei Überschreitung dieser Grenzen auf 21,6 mA
AP5	Randbedeckung: Analogbereich kleiner 5 mm bei Änderung Schritt 1 / Schritt 2		Teach-Tasten A+B > 2 Sek. betätigen	Pin 5+7 > 0,1 Sek. auf +U _b (>6V) legen GY 5 (A) + BU 7 (B)		Teach-Tasten A+B > 2 Sek. betätigen	Pin 5+7 > 0,1 Sek. auf +U _b (>6V) legen GY 5 (A) + BU 7 (B)	Beide LEDs blinken 4x 		Es wird ein Analogbereich von 5 mm (± 2,5 mm) um den Wert Schritt 1 gelegt: 10 mm = 12 mA 7,5 mm = 4 mA 12,5 mm = 20 mA
AP6	Teilbedeckung: Analogbereich kleiner 5 mm bei Änderung Schritt 1 / Schritt 2		Teach-Tasten A+B > 2 Sek. betätigen	Pin 5+7 > 0,1 Sek. auf +U _b (>6V) legen GY 5 (A) + BU 7 (B)		Teach-Tasten A+B > 2 Sek. betätigen	Pin 5+7 > 0,1 Sek. auf +U _b (>6V) legen GY 5 (A) + BU 7 (B)	Beide LEDs blinken 4x 		Es wird ein Analogbereich von 5 mm (± 2,5 mm) um den Wert Schritt 1 gelegt: 15 mm = 12 mA 12,5 mm = 4 mA 17,5 mm = 20 mA
AP7	Schlitzvermessung: Analogbereich kleiner 5 mm bei Änderung Schritt 1 / Schritt 2		Teach-Tasten A+B > 2 Sek. betätigen	Pin 5+7 > 0,1 Sek. auf +U _b (>6V) legen GY 5 (A) + BU 7 (B)		Teach-Tasten A+B > 2 Sek. betätigen	Pin 5+7 > 0,1 Sek. auf +U _b (>6V) legen GY 5 (A) + BU 7 (B)	Beide LEDs blinken 4x 		Es wird ein Analogbereich von 5 mm (± 2,5 mm) um den Wert Schritt 1 gelegt: Schlitzbreite 3 mm = 12 mA Schlitzbreite 0,5 mm = 4 mA Schlitzbreite 5,5 mm = 20 mA

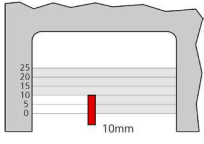
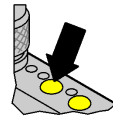
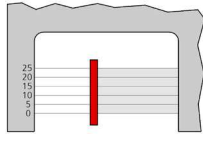
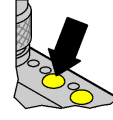
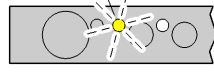
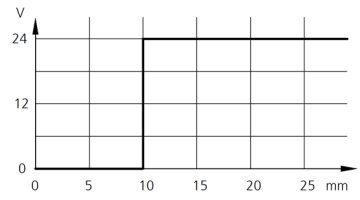

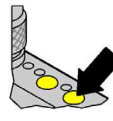
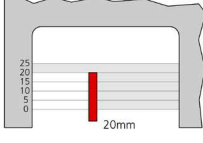
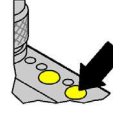
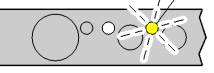
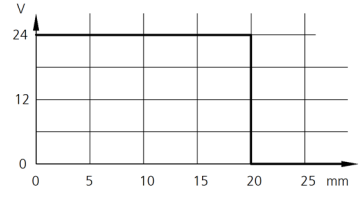
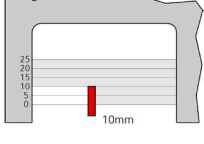
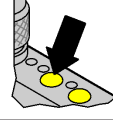
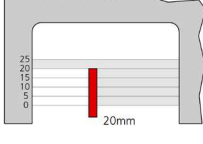
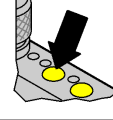
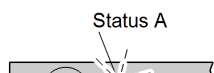
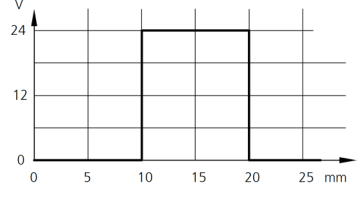
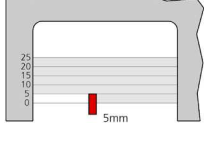
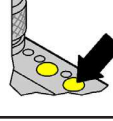
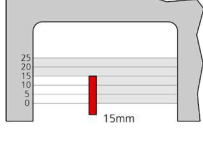
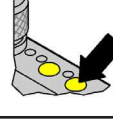
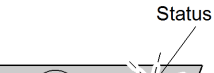
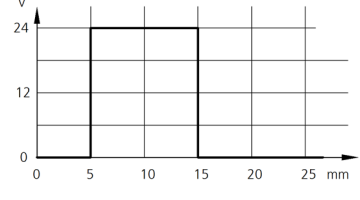
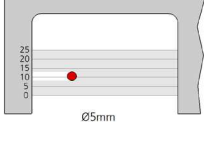
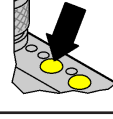
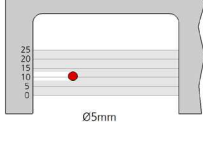
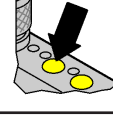
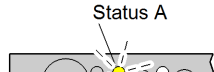
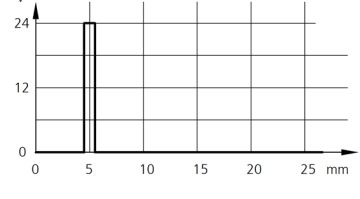
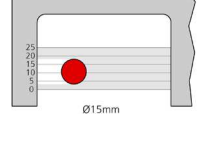
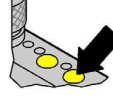
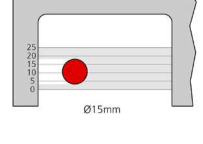
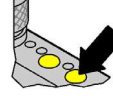
Hinweise	Schritt 1	Hinweis 1	Hinweis 2	Hinweis 3	Schritt 2 innerhalb 20 Sekunden	Ergebnis LED	Beschreibung Ergebnis
 <p>Ausgang A oder B: Zeit zwischen Schritt 1 und Schritt 2 < 20 Sek.</p>	Teach-Taste A oder B > 2 Sek. betätigen	Power LED erlischt sofort		Status-LED A oder B blinkt 20 Sek.	Teach-Taste A oder B < 2 Sek. betätigen	Beide LEDs blinken 2x	Zur Speicherung der Werte muss das Einlesen der Schritte 1 und 2 innerhalb 20 Sek. erfolgen.
 <p>Ausgang A oder B: Zeit zwischen Schritt 1 und Schritt 2 > 20 Sek.</p>			Status-LED A oder B: > 2 Sek. an			Beide LEDs blinken 4x	Bei Überschreiten der maximal zulässigen Zeit zwischen Schritt 1 und 2 (< 20 Sek.) bleiben die alten Werte erhalten!

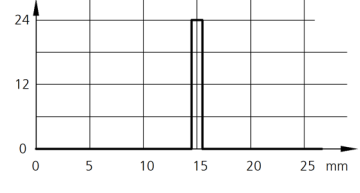
Pos.	Grundeinstellungen Schaltausgang A / B	Schritt 1	Hinweis 1	Hinweis 2	Schritt 2	Ergebnis LED	Ergebnis Diagramm		Beschreibung Ergebnis
S1	Invertierung des Schaltausgang A	Teach-Taste A > 6 Sek. drücken und halten	Power LED erlischt sofort	Status-LED A: > 2 Sek. an; > 6 Sek. Blinkmodus	Teach-Taste A loslassen	Status-LED A blinkt 2x	Status A vor der Invertierung	Status A nach der Invertierung	Die Schaltschwellen werden beibehalten und die Ausgangsfunktion invertiert
S2	Invertierung des Schaltausgang B	Teach-Taste B > 6 Sek. drücken und halten	Power LED erlischt sofort	Status-LED B: > 2 Sek. an; > 6 Sek. Blinkmodus	Teach-Taste B loslassen	Status-LED B blinkt 2x			Die Schaltschwellen werden beibehalten und die Ausgangsfunktion invertiert
S3	Schaltausgangsbereich um Ausgang A wird < 1 mm definiert	Teach-Taste A > 2 Sek.	Power LED erlischt sofort	Objekt verbleibt unverändert zwischen Schritt 1 und Schritt 2 in der aktiven Zone	Teach-Taste A < 2 Sek.	Status-LED A blinkt 4x			Es wird ein Schaltbereich von +/- 0,5 mm um den Teachwert 1 auf Ausgang A ausgegeben
S4	Schaltausgangsbereich um Ausgang B wird < 1 mm definiert	Teach-Taste B > 2 Sek.	Power LED erlischt sofort	Objekt verbleibt unverändert zwischen Schritt 1 und Schritt 2 in der aktiven Zone	Teach-Taste B < 2 Sek.	Status-LED B blinkt 4x			Es wird ein Schaltbereich von +/- 0,5 mm um den Teachwert 1 auf Ausgang B ausgegeben

Pos.	Applikationsbeispiele Schaltausgang A / B	Schritt 1:	per Tasten	per Fernteach	Schritt 2:	per Tasten	per Fernteach	Ergebnis LED	Ergebnis Diagramm	Beschreibung Ergebnis
SP1	Schaltausgang A soll ab einer Bedeckung von 10 mm schalten - Schaltschwelle		Teach-Taste A > 2 Sek. betätigen 	Pin 5 > 0,1 Sek. auf +U _b (>6V) legen GY 5 (A)		Teach-Taste A > 2 Sek. betätigen 	Pin 5 > 0,1 Sek. auf +U _b (>6V) legen GY 5 (A)	Status-LED A blinkt 2x 		Invertierung des Schaltausgangs NO/NC (siehe Grundeinstellung Punkt S1 und S2)
SP2	Schaltausgang B soll bis zu einer Bedeckung von 20 mm schalten - Schaltschwelle		Teach-Taste B > 2 Sek. betätigen 	Pin 7 > 0,1 Sek. auf +U _b (>6V) legen BU 7 (B)		Teach-Taste B > 2 Sek. betätigen 	Pin 7 > 0,1 Sek. auf +U _b (>6V) legen BU 7 (B)	Status-LED B blinkt 2x 		Invertierung des Schaltausgangs NO/NC (siehe Grundeinstellung Punkt S1 und S2)
SP3	Schaltausgang A soll ab einer Bedeckung von 10 bis 20 mm schalten - Fenstermodus		Teach-Taste A > 2 Sek. betätigen 	Pin 5 > 0,1 Sek. auf +U _b (>6V) legen GY 5 (A)		Teach-Taste A > 2 Sek. betätigen 	Pin 5 > 0,1 Sek. auf +U _b (>6V) legen GY 5 (A)	Status-LED A blinkt 2x 		Invertierung des Schaltausgangs NO/NC (siehe Grundeinstellung Punkt S1 und S2)
SP4	Schaltausgang B soll ab einer Bedeckung von 5 bis 15 mm schalten - Fenstermodus		Teach-Taste B > 2 Sek. betätigen 	Pin 7 > 0,1 Sek. auf +U _b (>6V) legen BU 7 (B)		Teach-Taste B > 2 Sek. betätigen 	Pin 7 > 0,1 Sek. auf +U _b (>6V) legen BU 7 (B)	Status-LED B blinkt 2x 		Invertierung des Schaltausgangs NO/NC (siehe Grundeinstellung Punkt S1 und S2)
SP5	Schaltausgang A soll bei einer Objektgröße von 5 mm +/- 0,5 mm schalten		Teach-Taste A > 2 Sek. betätigen 	Pin 5 > 0,1 Sek. auf +U _b (>6V) legen GY 5 (A)		Teach-Taste A > 2 Sek. betätigen 	Pin 5 > 0,1 Sek. auf +U _b (>6V) legen GY 5 (A)	Status-LED A blinkt 4x 		Ausgang A schaltet bei einer Abdeckung von 4,5...5,5 mm
SP6	Schaltausgang B soll bei einer Objektgröße von 15 mm +/- 0,5 mm schalten		Teach-Taste B > 2 Sek. betätigen 	Pin 7 > 0,1 Sek. auf +U _b (>6V) legen BU 7 (B)		Teach-Taste B > 2 Sek. betätigen 	Pin 7 > 0,1 Sek. auf +U _b (>6V) legen BU 7 (B)	Status-LED B blinkt 4x 		Ausgang B schaltet bei einer Abdeckung von 14,5... 15,5 mm



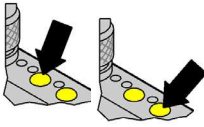
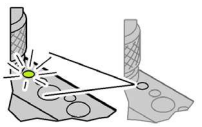
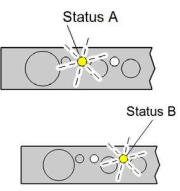
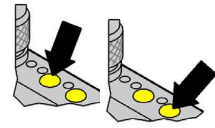
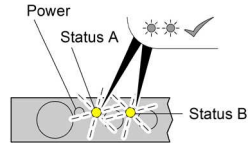

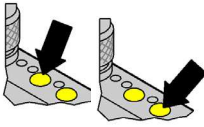
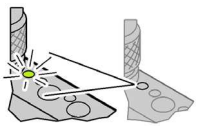
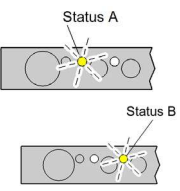
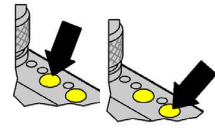
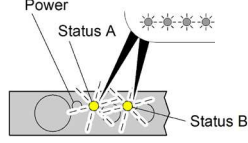

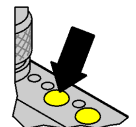
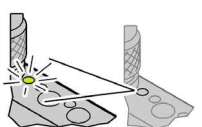
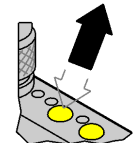
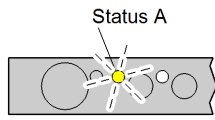
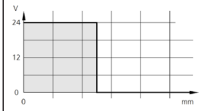
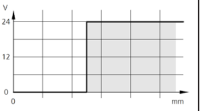
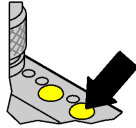
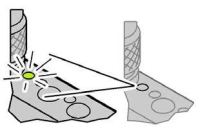
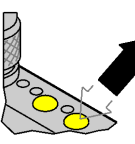
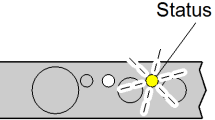
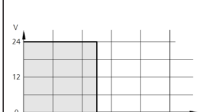
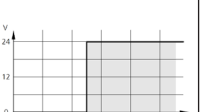
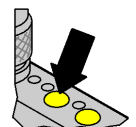
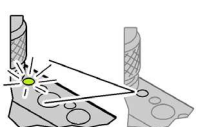
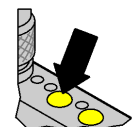
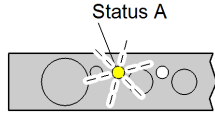
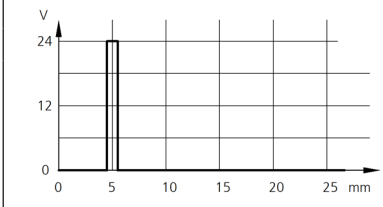
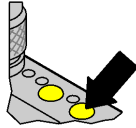
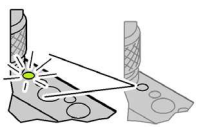
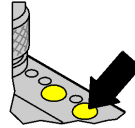
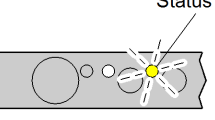
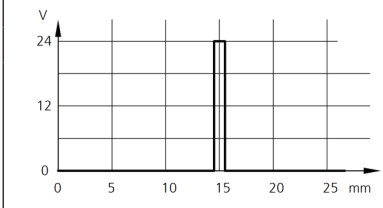

Pos.	Basic settings analog output	Action 1	Reference 1	Reference 2	Action 2	Result LED	Result diagramm	Description result
A1	Restoring to Factory default	Push and hold buttons > 10 sec. 	Power LED extinguishes immediately 	Both LEDs: >2 sec. on; >6 sec. off; > 10 sec. flash	Release both buttons 	Both LEDs flash 2x Power Status A Status B 		no cover 4 mA, full cover 20 mA Output A: 2,8...28 % (High) Output B: 14...84 % (High)
A2	Switching the analog output from 4...20 mA to 0...10VDC	Push and hold buttons > 6 sec. 	Power LED extinguishes immediately 	Both LEDs turn on >2 sec. and turn off >6 sec.	Release both buttons 	Both LEDs alternately flash fast 2x Status A Status B 		Output signal 0...10 V
A3	Switching the analog output from 0...10VDC to 4...20 mA	Push and hold buttons > 6 sec. 	Power LED extinguishes immediately 	Both LEDs turn off after >6 sec.	Release both buttons 	Both LEDs alternately flash slow 2x Status A Status B 		Output signal 4...20 mA
A4	Start analog teaching procedure = Teaching step 1	Push and hold buttons > 2 sec. 	Power LED extinguishes immediately 	Both LEDs turn on after >2 sec.	Release both buttons 	Both LEDs flash 20 sec. Power Status A Status B 		For changing the values step 2 has to be completed within 20 sec, otherwise the original values remain unchanged.
A4.1	Teach area > 5 mm < 25 mm Finish analog teach procedure within 20 sec. = Teaching step 2	Push and hold buttons < 2 sec. 	Power LED extinguishes immediately 	Both LEDs turn off immediately 	Release both buttons 	Both LEDs flash 2x Power Status A Status B 		confirmation of a successful teach procedure is indicated by flashing 2x.
A4.2	Teach area < 5 mm Teach area is too small Teach procedure analog must be finished in 20 sec. = Teaching step 2	Push and hold buttons < 2 sec. 	Power LED extinguishes immediately 	Both LEDs turn off immediately 	Release both buttons 	Both LEDs flash 4x Power Status A Status B 		Flashing 4x means to small of an analog area, the analog area will be set with a value of ±2,5 mm as monitored in step 1
A5	Teach process with external teach wires: 2xsignal > 0,1 sec. on both inputs for step 1 and step 2	Put Pin 5+7 > 0,1 sec. on +U _b (>6V) 	Both LEDs flash for 20 sec. Power Status A Status B 	Second teach procedure should be effected within 20 sec.! 	Put Pin 5+7 > 0,1 sec. on +U _b (>6V) 	Both LEDs flash 2x Power Status A Status B 		Flashing 2x means a successful teach procedure. For changing the values step 2 has to be completed within 20 sec, otherwise the original values remain unchanged.

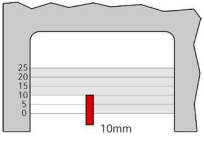
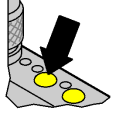
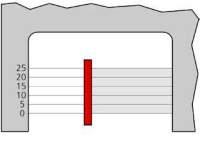
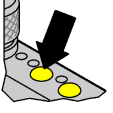
Pos.	Application examples analog output	Step 1:	with buttons	with remote teach	Step 2:	with buttons	with remote teach	Result LED	Result diagramm	Description result
AP1	Set measuring range by rising characteristic: Area free = 4 mA Area completely covered = 20 mA		Push teach-buttons A+B > 2 sec.	Put Pin 5+7 > 0,1 sec. on +U _B (>6V) GY 5 (A) + BU 7 (B)		Push teach-buttons A+B > 2 sec.	Put Pin 5+7 > 0,1 sec. on +U _B (>6V) GY 5 (A) + BU 7 (B)	Both LEDs flash 2x 		Area free = 4 mA Area completely covered = 20 mA
AP2	Set measuring range by falling characteristic: Area free = 20 mA Area completely covered = 4 mA		Push teach-buttons A+B > 2 sec.	Put Pin 5+7 > 0,1 sec. on +U _B (>6V) GY 5 (A) + BU 7 (B)		Push teach-buttons A+B > 2 sec.	Put Pin 5+7 > 0,1 sec. on +U _B (>6V) GY 5 (A) + BU 7 (B)	Both LEDs flash 2x 		Area free = 20 mA Area completely covered = 4 mA
AP3	Set limited measuring range by rising characteristic: 5 mm covered = 4 mA 15 mm covered = 20 mA		Push teach-buttons A+B > 2 sec.	Put Pin 5+7 > 0,1 sec. on +U _B (>6V) GY 5 (A) + BU 7 (B)		Push teach-buttons A+B > 2 sec.	Put Pin 5+7 > 0,1 sec. on +U _B (>6V) GY 5 (A) + BU 7 (B)	Both LEDs flash 2x 		Object size < 5 mm: -Analog output reduces to 3,2 mA Object size > 15 mm: -Analog output increases to 20,8 mA Exceeding object size the analog output will switch to 21,6 mA
AP4	Set limited measuring range by falling characteristic: 15 mm covered = 4 mA 5 mm covered = 20 mA		Push teach-buttons A+B > 2 sec.	Put Pin 5+7 > 0,1 sec. on +U _B (>6V) GY 5 (A) + BU 7 (B)		Push teach-buttons A+B > 2 sec.	Put Pin 5+7 > 0,1 sec. on +U _B (>6V) GY 5 (A) + BU 7 (B)	Both LEDs flash 2x 		Object size < 5 mm: -Analog output increases to 20,8 mA Object size > 15 mm: -Analog output reduces to 3,2 mA Exceeding the object size, the analog output will switch to 21,6 mA
AP5	Edge coverage: Analog area smaller than 5 mm with changes (Step 1 / Step 2)		Push teach-buttons A+B > 2 sec.	Put Pin 5+7 > 0,1 sec. on +U _B (>6V) GY 5 (A) + BU 7 (B)		Push teach-buttons A+B > 2 sec.	Put Pin 5+7 > 0,1 sec. on +U _B (>6V) GY 5 (A) + BU 7 (B)	Both LEDs flash 4x 		The step 1 value would be within a tolerance ± 2,5 mm: 10 mm = 12 mA 7,5 mm = 4 mA 12,5 mm = 20 mA
AP6	Partial coverage: Analog area smaller than 5 mm with changes Step (1 / Step 2)		Push teach-buttons A+B > 2 sec.	Put Pin 5+7 > 0,1 sec. on +U _B (>6V) GY 5 (A) + BU 7 (B)		Push teach-buttons A+B > 2 sec.	Put Pin 5+7 > 0,1 sec. on +U _B (>6V) GY 5 (A) + BU 7 (B)	Both LEDs flash 4x 		The step 1 value would be within a tolerance ± 2,5 mm: 15 mm = 12 mA 12,5 mm = 4 mA 17,5 mm = 20 mA
AP7	Slot measuring: Analog area smaller than 5 mm with changes Step (1 / Step 2)		Push teach-buttons A+B > 2 sec.	Put Pin 5+7 > 0,1 sec. on +U _B (>6V) GY 5 (A) + BU 7 (B)		Push teach-buttons A+B > 2 sec.	Put Pin 5+7 > 0,1 sec. on +U _B (>6V) GY 5 (A) + BU 7 (B)	Both LEDs flash 4x 		The step 1 value would be within a tolerance ± 2,5 mm: Slot width 3 mm = 12 mA Slot width 0,5 mm = 4 mA Slot width 5,5 mm = 20 mA

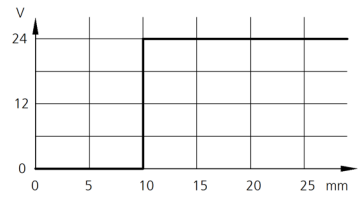
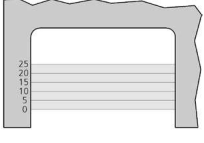
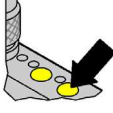
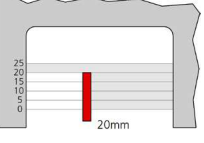
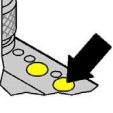

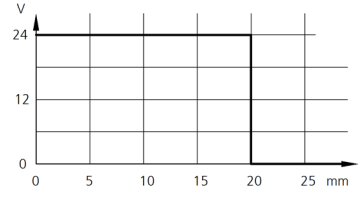
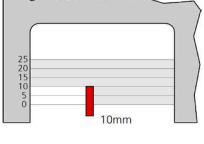
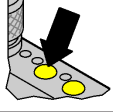
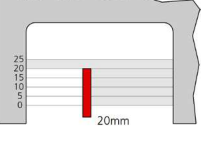
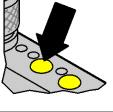
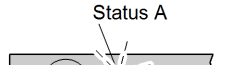
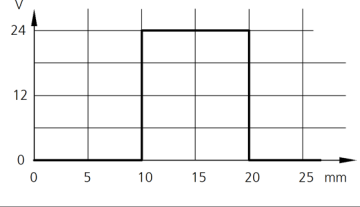
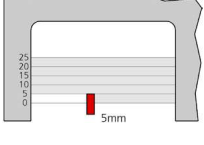
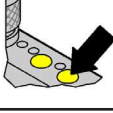
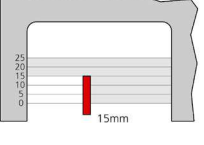
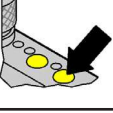

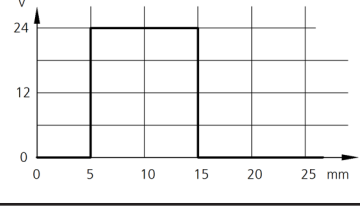
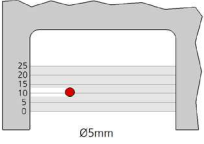
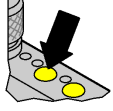
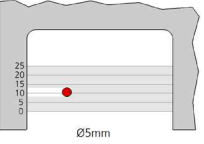
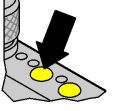
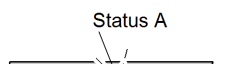
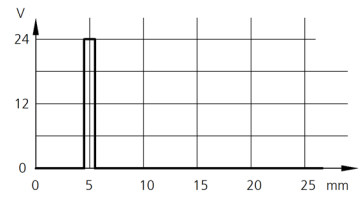
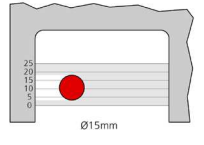
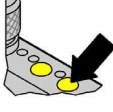
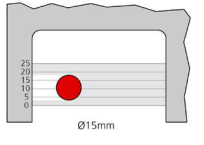
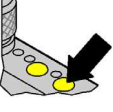
Reference	Step 1	Reference 1	Reference 2	Reference 3	Step 2 within 20 seconds	Result LED	Description Result
 <p>Output A or B: Time between step 1 and step 2 < 20 Sec.</p>	<p>Push teach-button A or B > 2 sec.</p> 	<p>Power LED extinguishes immediately</p> 	<p>Status-LED A or B: > 2 sec. on</p>	<p>Status-LED A or B flash 20 sec.</p> 	<p>Push teach-button A or B < 2 sec.</p> 	<p>Both LEDs flash 2x</p> 	<p>For saving the values step 1 and step 2 must be taught within 20 sec.</p>
 <p>Output A or B: Time between step 1 and step 2 > 20 Sec.</p>			<p>Status-LED A or B: > 2 sec. on</p>			<p>Both LEDs blink 4x</p> 	<p>Exceeding the allowable time between Step 1 and 2 (< 20 sec.) the original values will be retained!</p>

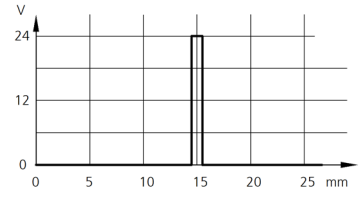
Pos.	Basic settings switching output A / B	Step 1	Reference 1	Reference 2	Step 2	Result LED	Result diagram		Description Result
S1	Inversion of switching output A	<p>Push and hold teach button A > 6 sec.</p> 	<p>Power LED extinguishes immediately</p> 	<p>Status-LED A: > 2 sec. on; Flashing mode > 6 sec.</p>	<p>Release teach button A</p> 	<p>Status-LED A flash 2x</p> 	<p>Status A before inversion</p> 	<p>Status A after inversion</p> 	<p>Switching threshold will be stored and the output function will be inverted</p>
S2	Inversion of switching output B	<p>Push and hold teach button B > 6 sec.</p> 	<p>Power LED extinguishes immediately</p> 	<p>Status-LED B: > 2 sec. on; Flashing mode > 6 sec.</p>	<p>Release teach button B</p> 	<p>Status-LED B flash 2x</p> 			<p>Switching threshold will be stored and the output function will be inverted</p>
S3	Switching output area at output A is < 1 mm	<p>Push and hold teach button A > 2 sec.</p> 	<p>Power LED extinguishes immediately</p> 	<p>Object remains unchanged between step 1 and step 2 in the active area</p>	<p>Push teach-button A < 2 sec.</p> 	<p>Status-LED A flash 4x</p> 			<p>Switching area of +/- 0,5 mm around the taught value on output A</p>
S4	Switching output area at output B is < 1 mm	<p>Push and hold teach button B > 2 sec.</p> 	<p>Power LED extinguishes immediately</p> 	<p>Object remains unchanged between step 1 and step 2 in the active area</p>	<p>Push teach-button B < 2 sec.</p> 	<p>Status-LED B flash 4x</p> 			<p>Switching area of +/- 0,5 mm around the taught value on output B</p>

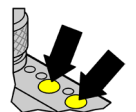
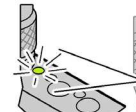
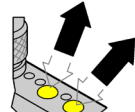
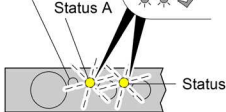
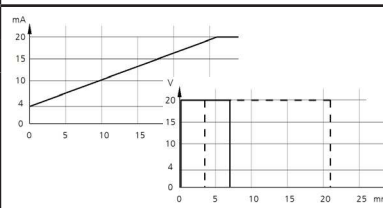
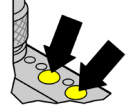

English

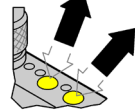
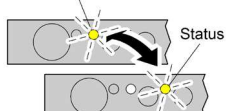
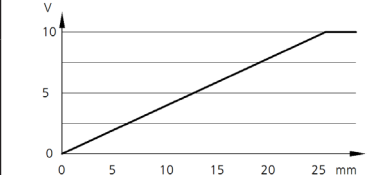
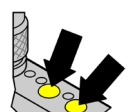
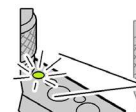
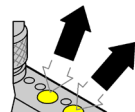
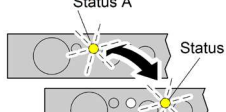
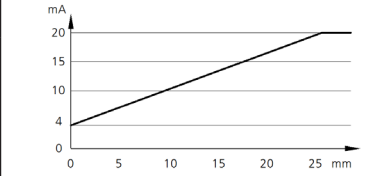
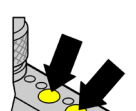
Pos.	Application examples switching output A / B	Step 1:	with buttons	with remote teach	Step 2:	with buttons	with remote teach	Result LED	Result diagram	Description Result
SP1	Switching output A should switch after reaching a coverage of 10 mm - switching threshold		Push teach-button A > 2 sec. 	Put Pin 5 > 0,1 sec. on +U _b (>6V) GY 5 (A)		Push teach-button A > 2 sec. 	Put Pin 5 > 0,1 sec. on +U _b (>6V) GY 5 (A)	Status-LED A flash 2x 		Inversion of the switching output (see factory defaults Step S1 and S2)
SP2	Switching output B should switch after reaching a coverage of 20 mm - switching threshold		Push teach-button B > 2 sec. 	Put Pin 7 > 0,1 sec. on +U _b (>6V) BU 7 (B)		Push teach-button B > 2 sec. 	Put Pin 7 > 0,1 sec. on +U _b (>6V) BU 7 (B)	Status-LED B flash 2x 		Inversion of the switching output (see factory defaults Step S1 and S2)
SP3	Switching output A should switch after reaching a coverage of 10...20 mm - window mode		Push teach-button A > 2 sec. 	Put Pin 5 > 0,1 sec. on +U _b (>6V) GY 5 (A)		Push teach-button A > 2 sec. 	Put Pin 5 > 0,1 sec. on +U _b (>6V) GY 5 (A)	Status-LED A flash 2x 		Inversion of the switching output (see factory defaults Step S1 and S2)
SP4	Switching output B should switch after reaching a coverage of 5...15 mm - window mode		Push teach-button B > 2 sec. 	Put Pin 7 > 0,1 sec. on +U _b (>6V) BU 7 (B)		Push teach-button B > 2 sec. 	Put Pin 7 > 0,1 sec. on +U _b (>6V) BU 7 (B)	Status-LED B flash 2x 		Inversion of the switching output (see factory defaults Step S1 and S2)
SP5	Output A should switch by a objekt size of 5 mm +/- 0,5 mm		Push teach-button A > 2 sec. 	Put Pin 5 > 0,1 sec. on +U _b (>6V) GY 5 (A)		Push teach-button A > 2 sec. 	Put Pin 5 > 0,1 sec. on +U _b (>6V) GY 5 (A)	Status-LED A flash 4x 		Output A switches to a coverage of 4,5...5,5 mm
SP6	Output B should switch by a objekt size of 15 mm +/- 0,5 mm		Push teach-button B > 2 sec. 	Put Pin 7 > 0,1 sec. on +U _b (>6V) BU 7 (B)		Push teach-button B > 2 sec. 	Put Pin 7 > 0,1 sec. on +U _b (>6V) BU 7 (B)	Status-LED B flash 4x 		Output A switches to a coverage of 14,5...15,5 mm

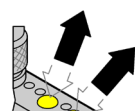
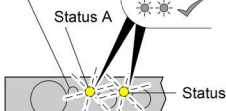
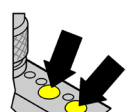
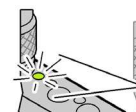
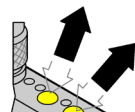
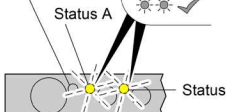
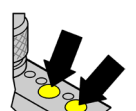
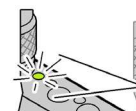
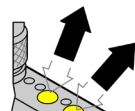
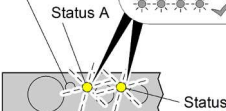
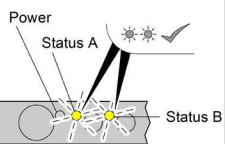
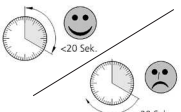
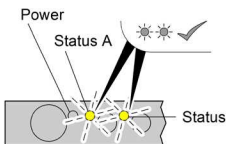



französisch

Pos.	Analogausgang Grundeinstellungen	Aktion 1	Hinweis 1	Hinweis 2	Aktion 2	Ergebnis LED	Ergebnis Diagramm	Beschreibung Ergebnis
A1	Wiederherstellung der Werkseinstellung	Beide Tasten > 10 Sek. drücken und halten 	Power LED erlischt sofort 	Beide LEDs: >2 Sek. an; >6Sek. aus; >10Sek. blinken	Beide Tasten loslassen 	Beide LEDs blinken 2x 		keine Bedeckung 4 mA, volle Bedeckung 20 mA Out A: 2,8...28% (High) Out B: 14...84% (High)
A2	Umschaltung des Analogausgangs 4...20 mA / 0...10VDC	Beide Tasten > 6 Sek. drücken und halten 	Power LED erlischt sofort 	Beide LEDs gehen nach >2Sek. an und nach >6Sek. wieder aus	Beide Tasten loslassen 	Beide LEDs blinken schnell im Wechsel 2x Status A Status B 		Ausgangssignal 0...10 V
A3	Umschaltung des Analogausgangs 0...10VDC / 4...20 mA	Beide Tasten > 6 Sek. drücken und halten 	Power LED erlischt sofort 	Beide LEDs gehen nach >6Sek. aus	Beide Tasten loslassen 	Beide LEDs blinken langsam im Wechsel 2x Status A Status B 		Ausgangssignal 4...20 mA
A4	Teachvorgang Analog einleiten = Schritt 1 einlernen	Beide Tasten > 2 Sek. drücken und halten 	Power LED erlischt sofort 	Beide LEDs gehen nach >2 Sek. an	Beide Tasten loslassen 	Beide LEDs blinken 20 Sek. Power Status A Status B 		Zum Ändern der Werte muss innerhalb 20 Sek. Schritt 2 erfolgen, ansonsten bleiben die alten Werte erhalten!
A4.1	Teachbereich > 5 mm < 25 mm Teachvorgang Analog innerhalb 20 Sek. fertig stellen = Schritt 2 einlernen	Beide Tasten < 2 Sek. drücken und halten 	Power LED erlischt sofort 	Beide LEDs gehen sofort aus	Beide Tasten loslassen 	Beide LEDs blinken 2x Power Status A Status B 		2-maliges Blinken signalisiert den erfolgreichen Teachvorgang
A4.2	Teachbereich < 5 mm Teachbereich zu klein Teachvorgang Analog innerhalb 20 Sek. fertig stellen = Schritt 2 einlernen	Beide Tasten < 2 Sek. drücken und halten 	Power LED erlischt sofort 	Beide LEDs gehen sofort aus	Beide Tasten loslassen 	Beide LEDs blinken 4x Power Status A Status B 		4-maliges Blinken signalisiert einen zu kleinen Analogbereich, der Analogbereich wird auf ±2,5 mm um Schritt 1 gelegt
A5	Teachvorgang mit externen Leitungen: 2xSignal > 0,1 Sek. an beiden Eingängen für Schritt 1 und Schritt 2	Pin 5+7 > 0,1 Sek. auf +U _b (>6V) legen GY 5 (A) — + BU 7 (B) —	20 Sek. blinken beider LEDs Power Status A Status B 	Innerhalb von 20 Sek. muss der zweite Teachvorgang erfolgen! 	Pin 5+7 > 0,1 Sek. auf +U _b (>6V) legen GY 5 (A) — + BU 7 (B) —	Beide LEDs blinken 2x Power Status A Status B 		2-maliges Blinken signalisiert den erfolgreichen Teachvorgang Zum Ändern der Werte muss innerhalb 20 Sek. Schritt 2 erfolgen, ansonsten bleiben die alten Werte erhalten!

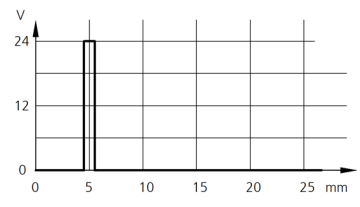
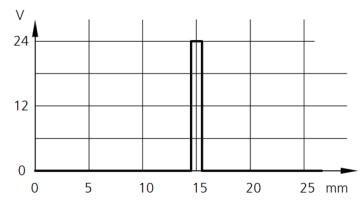
Pos.	Analogausgang Applikationsbeispiele	Schritt 1:	per Tasten	per Fernteach	Schritt 2:	per Tasten	per Fernteach	Ergebnis LED	Ergebnis Diagramm	Beschreibung Ergebnis
AP1	Messbereich bei steigender Kennlinie definieren: Zone frei = 4 mA Zone kpl. bedeckt = 20 mA		Teach-Tasten A+B > 2 Sek. betätigen	Pin 5+7 > 0,1 Sek. auf +U _b (>6V) legen GY 5 (A) + BU 7 (B)		Teach-Tasten A+B > 2 Sek. betätigen	Pin 5+7 > 0,1 Sek. auf +U _b (>6V) legen GY 5 (A) + BU 7 (B)	Beide LEDs blinken 2x 		Zone frei = 4 mA Zone kpl. bedeckt = 20 mA
AP2	Messbereich bei fallender (invertierter) Kennlinie definieren: Zone frei = 20 mA Zone kpl. bedeckt = 4 mA		Teach-Tasten A+B > 2 Sek. betätigen	Pin 5+7 > 0,1 Sek. auf +U _b (>6V) legen GY 5 (A) + BU 7 (B)		Teach-Tasten A+B > 2 Sek. betätigen	Pin 5+7 > 0,1 Sek. auf +U _b (>6V) legen GY 5 (A) + BU 7 (B)	Beide LEDs blinken 2x 		Zone frei = 20 mA Zone kpl. bedeckt = 4 mA
AP3	Eingeengter Messbereich bei steigender Kennlinie definieren: 5 mm bedeckt = 4 mA 15 mm bedeckt = 20 mA		Teach-Tasten A+B > 2 Sek. betätigen	Pin 5+7 > 0,1 Sek. auf +U _b (>6V) legen GY 5 (A) + BU 7 (B)		Teach-Tasten A+B > 2 Sek. betätigen	Pin 5+7 > 0,1 Sek. auf +U _b (>6V) legen GY 5 (A) + BU 7 (B)	Beide LEDs blinken 2x 		Der Analogausgang sinkt bei unter 5mm auf 3,2 mA oder steigt über 15mm auf 20,8 mA und springt bei Überschreitung dieser Grenzen auf 21,6 mA
AP4	Eingeengter Messbereich bei fallender (invertierter) Kennlinie definieren: 15 mm bedeckt = 4 mA 5 mm bedeckt = 20 mA		Teach-Tasten A+B > 2 Sek. betätigen	Pin 5+7 > 0,1 Sek. auf +U _b (>6V) legen GY 5 (A) + BU 7 (B)		Teach-Tasten A+B > 2 Sek. betätigen	Pin 5+7 > 0,1 Sek. auf +U _b (>6V) legen GY 5 (A) + BU 7 (B)	Beide LEDs blinken 2x 		Der Analogausgang steigt bei unter 5mm auf 20,8 mA oder sinkt über 15mm auf 3,2 mA und springt bei Überschreitung dieser Grenzen auf 21,6 mA
AP5	Randbedeckung: Analogbereich kleiner 5 mm bei Änderung Schritt 1 / Schritt 2		Teach-Tasten A+B > 2 Sek. betätigen	Pin 5+7 > 0,1 Sek. auf +U _b (>6V) legen GY 5 (A) + BU 7 (B)		Teach-Tasten A+B > 2 Sek. betätigen	Pin 5+7 > 0,1 Sek. auf +U _b (>6V) legen GY 5 (A) + BU 7 (B)	Beide LEDs blinken 4x 		Es wird ein Analogbereich von 5 mm (± 2,5 mm) um den Wert Schritt 1 gelegt: 10 mm = 12 mA 7,5 mm = 4 mA 12,5 mm = 20 mA
AP6	Teilbedeckung: Analogbereich kleiner 5 mm bei Änderung Schritt 1 / Schritt 2		Teach-Tasten A+B > 2 Sek. betätigen	Pin 5+7 > 0,1 Sek. auf +U _b (>6V) legen GY 5 (A) + BU 7 (B)		Teach-Tasten A+B > 2 Sek. betätigen	Pin 5+7 > 0,1 Sek. auf +U _b (>6V) legen GY 5 (A) + BU 7 (B)	Beide LEDs blinken 4x 		Es wird ein Analogbereich von 5 mm (± 2,5 mm) um den Wert Schritt 1 gelegt: 15 mm = 12 mA 12,5 mm = 4 mA 17,5 mm = 20 mA
AP7	Schlitzvermessung: Analogbereich kleiner 5 mm bei Änderung Schritt 1 / Schritt 2		Teach-Tasten A+B > 2 Sek. betätigen	Pin 5+7 > 0,1 Sek. auf +U _b (>6V) legen GY 5 (A) + BU 7 (B)		Teach-Tasten A+B > 2 Sek. betätigen	Pin 5+7 > 0,1 Sek. auf +U _b (>6V) legen GY 5 (A) + BU 7 (B)	Beide LEDs blinken 4x 		Es wird ein Analogbereich von 5 mm (± 2,5 mm) um den Wert Schritt 1 gelegt: Schlitzbreite 3 mm = 12 mA Schlitzbreite 0,5 mm = 4 mA Schlitzbreite 5,5 mm = 20 mA

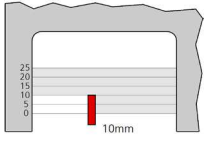
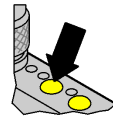
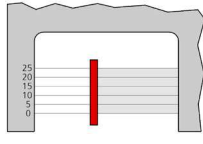
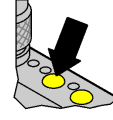
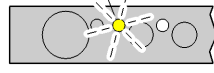
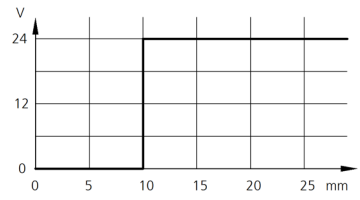
Hinweise	Schritt 1	Hinweis 1	Hinweis 2	Hinweis 3	Schritt 2 innerhalb 20 Sekunden	Ergebnis LED	Beschreibung Ergebnis
 <p>Ausgang A oder B: Zeit zwischen Schritt 1 und Schritt 2 < 20 Sek.</p>	Teach-Taste A oder B > 2 Sek. betätigen	Power LED erlischt sofort		Status-LED A oder B blinkt 20 Sek.	Teach-Taste A oder B < 2 Sek. betätigen	Beide LEDs blinken 2x	Zur Speicherung der Werte muss das Einlesen der Schritte 1 und 2 innerhalb 20 Sek. erfolgen.
 <p>Ausgang A oder B: Zeit zwischen Schritt 1 und Schritt 2 > 20 Sek.</p>			Status-LED A oder B: > 2 Sek. an			Beide LEDs blinken 4x	Bei Überschreiten der maximal zulässigen Zeit zwischen Schritt 1 und 2 (< 20 Sek.) bleiben die alten Werte erhalten!

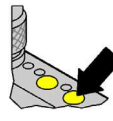
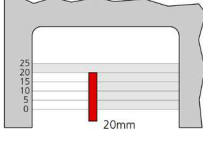
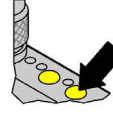
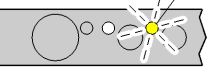
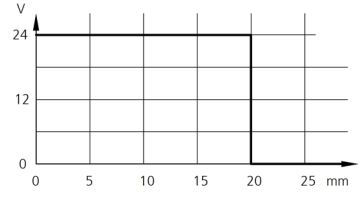
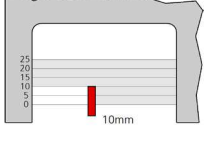
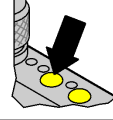
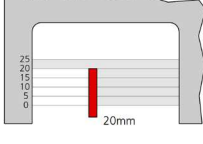
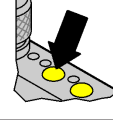
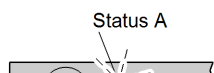
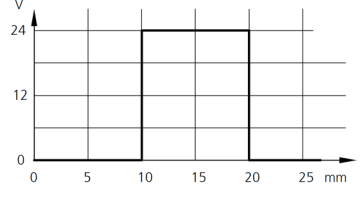
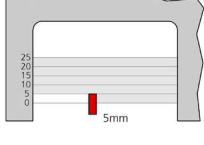
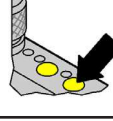
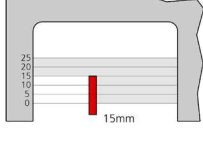
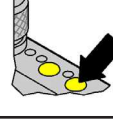
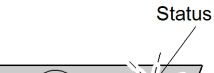
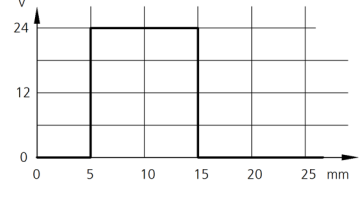
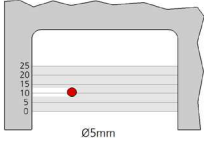
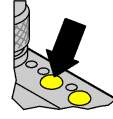
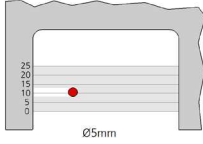
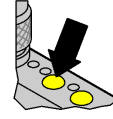
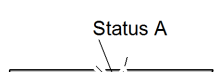
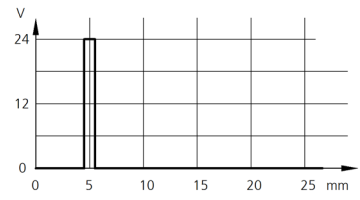
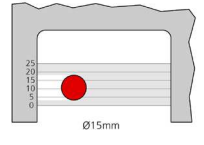
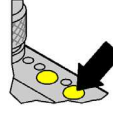
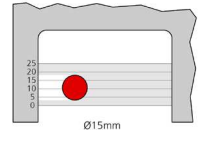
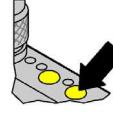
Pos.	Grundeinstellungen Schaltausgang A / B	Schritt 1	Hinweis 1	Hinweis 2	Schritt 2	Ergebnis LED	Ergebnis Diagramm		Beschreibung Ergebnis
S1	Invertierung des Schaltausgang A	Teach-Taste A > 6 Sek. drücken und halten	Power LED erlischt sofort	Status-LED A: > 2 Sek. an; > 6 Sek. Blinkmodus	Teach-Taste A loslassen	Status-LED A blinkt 2x	Status A vor der Invertierung	Status A nach der Invertierung	Die Schaltschwellen werden beibehalten und die Ausgangsfunktion invertiert
S2	Invertierung des Schaltausgang B	Teach-Taste B > 6 Sek. drücken und halten	Power LED erlischt sofort	Status-LED B: > 2 Sek. an; > 6 Sek. Blinkmodus	Teach-Taste B loslassen	Status-LED B blinkt 2x			Die Schaltschwellen werden beibehalten und die Ausgangsfunktion invertiert
S3	Schaltausgangsbereich um Ausgang A wird < 1 mm definiert	Teach-Taste A > 2 Sek.	Power LED erlischt sofort	Objekt verbleibt unverändert zwischen Schritt 1 und Schritt 2 in der aktiven Zone	Teach-Taste A < 2 Sek.	Status-LED A blinkt 4x			Es wird ein Schaltbereich von +/- 0,5 mm um den Teachwert 1 auf Ausgang A ausgegeben
S4	Schaltausgangsbereich um Ausgang B wird < 1 mm definiert	Teach-Taste B > 2 Sek.	Power LED erlischt sofort	Objekt verbleibt unverändert zwischen Schritt 1 und Schritt 2 in der aktiven Zone	Teach-Taste B < 2 Sek.	Status-LED B blinkt 4x			Es wird ein Schaltbereich von +/- 0,5 mm um den Teachwert 1 auf Ausgang B ausgegeben

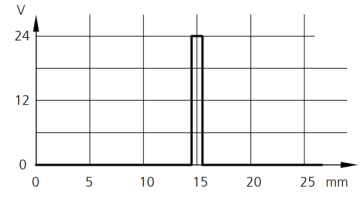
Pos.	Applikationsbeispiele Schaltausgang A / B	Schritt 1:	per Tasten	per Fernteach	Schritt 2:	per Tasten	per Fernteach	Ergebnis LED	Ergebnis Diagramm	Beschreibung Ergebnis
SP1	Schaltausgang A soll ab einer Bedeckung von 10 mm schalten - Schaltschwelle		Teach-Taste A > 2 Sek. betätigen 	Pin 5 > 0,1 Sek. auf +U _b (>6V) legen GY 5 (A)		Teach-Taste A > 2 Sek. betätigen 	Pin 5 > 0,1 Sek. auf +U _b (>6V) legen GY 5 (A)	Status-LED A blinkt 2x 		Invertierung des Schaltausgangs NO/NC (siehe Grundeinstellung Punkt S1 und S2)
SP2	Schaltausgang B soll bis zu einer Bedeckung von 20 mm schalten - Schaltschwelle		Teach-Taste B > 2 Sek. betätigen 	Pin 7 > 0,1 Sek. auf +U _b (>6V) legen BU 7 (B)		Teach-Taste B > 2 Sek. betätigen 	Pin 7 > 0,1 Sek. auf +U _b (>6V) legen BU 7 (B)	Status-LED B blinkt 2x 		Invertierung des Schaltausgangs NO/NC (siehe Grundeinstellung Punkt S1 und S2)
SP3	Schaltausgang A soll ab einer Bedeckung von 10 bis 20 mm schalten - Fenstermodus		Teach-Taste A > 2 Sek. betätigen 	Pin 5 > 0,1 Sek. auf +U _b (>6V) legen GY 5 (A)		Teach-Taste A > 2 Sek. betätigen 	Pin 5 > 0,1 Sek. auf +U _b (>6V) legen GY 5 (A)	Status-LED A blinkt 2x 		Invertierung des Schaltausgangs NO/NC (siehe Grundeinstellung Punkt S1 und S2)
SP4	Schaltausgang B soll ab einer Bedeckung von 5 bis 15 mm schalten - Fenstermodus		Teach-Taste B > 2 Sek. betätigen 	Pin 7 > 0,1 Sek. auf +U _b (>6V) legen BU 7 (B)		Teach-Taste B > 2 Sek. betätigen 	Pin 7 > 0,1 Sek. auf +U _b (>6V) legen BU 7 (B)	Status-LED B blinkt 2x 		Invertierung des Schaltausgangs NO/NC (siehe Grundeinstellung Punkt S1 und S2)
SP5	Schaltausgang A soll bei einer Objektgröße von 5 mm +/- 0,5 mm schalten		Teach-Taste A > 2 Sek. betätigen 	Pin 5 > 0,1 Sek. auf +U _b (>6V) legen GY 5 (A)		Teach-Taste A > 2 Sek. betätigen 	Pin 5 > 0,1 Sek. auf +U _b (>6V) legen GY 5 (A)	Status-LED A blinkt 4x 		Ausgang A schaltet bei einer Abdeckung von 4,5...5,5 mm
SP6	Schaltausgang B soll bei einer Objektgröße von 15 mm +/- 0,5 mm schalten		Teach-Taste B > 2 Sek. betätigen 	Pin 7 > 0,1 Sek. auf +U _b (>6V) legen BU 7 (B)		Teach-Taste B > 2 Sek. betätigen 	Pin 7 > 0,1 Sek. auf +U _b (>6V) legen BU 7 (B)	Status-LED B blinkt 4x 		Ausgang B schaltet bei einer Abdeckung von 14,5... 15,5 mm