

MZEC 3.7 PS-K-IBS

Zylindersensor
Cylinder sensor
Détecteur pour vérins

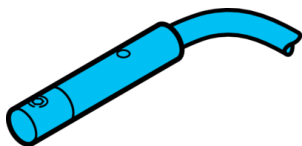

di-soric GmbH & Co. KG
Steinbeisstraße 6
DE-73660 Urbach
Germany
Tel: +49 (0) 7181/9879-0
info@di-soric.com · www.di-soric.com

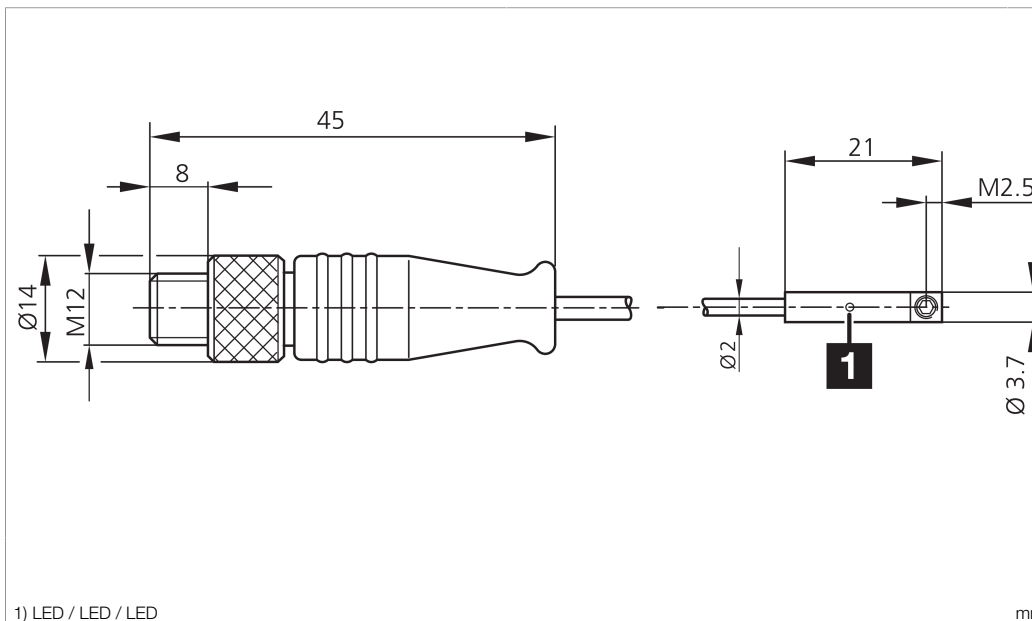

1) LED / LED / LED

mm

BK : schwarz / black / noir
BN : braun / brown / marron BU : blau / blue / bleu

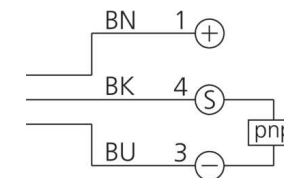

Technische Daten	Technical data	Caractéristiques techniques	+20°C, 24 V DC
Montage	Assembly	Montage	C-Nut / C-groove / Rainure en C
Betriebsspannung	Service voltage	Tension de service	10 ... 30 V DC
Schaltausgang	Switching output	Sortie de commutation	pnp, 100 mA, NO
Leerlaufstrom (max.)	No-load current (max.)	Courant de marche à vide (max.)	11 mA
Gehäusematerial	Housing material	Matériau du boîtier	Edelstahl, Kunststoff, V2A 1.4301 / AISI 304 / Stainless steel, Plastic, V2A 1.4301 / AISI 304 / Acier inoxydable, Plastique, V2A 1.4301 / AISI 304
Umgebungstemperatur Betrieb	Ambient temperature during operation	Température ambiante de fonctionnement	-20 ... +70 °C
Schutzart	Protection type	Indice de protection	IP 67
Anschluss	Connection	Raccordement	Pigtail, 0,3 m, M12, 3-polig / Pigtail, 0,3 m, M12, 3-pin / Pigtail, 0,3 m, M12, 3 pôles

Stand 22.10.24, Änderungen vorbehalten
As of 10/22/24, subject to change
État 22.10.24, sous réserve de modifications



Sicherheitshinweise	Safety instructions	Consignes de sécurité
Allgemeiner Sicherheitshinweis WARNUNG! Kein Sicherheitsbauteil gemäß 2006/42/EG und EN 61496-1 /-2! Darf nicht zum Personenschutz eingesetzt werden! Nichtbeachtung kann zu Tod oder schwersten Verletzungen führen! Nur bestimmungsgemäß verwenden!	General safety notice WARNING! Not a safety component pursuant to 2006/42/EG and EN 61496-1/-2! May not be used for personal protection! Non-compliance can lead to death or serious injuries! Only use as directed!	Consigne de sécurité générale AVERTISSEMENT ! Ce produit n'est pas un composant de sécurité au sens des réglementations 2006/42/CE et NF EN 61496-1/-2 ! Ne pas l'utiliser pour la protection des personnes ! Le non-respect de cette consigne peut entraîner la mort ou des blessures graves ! N'utiliser le produit que selon son utilisation conforme !

MZEC 3.7 PS-K-IBS

气缸传感器

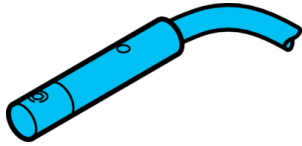

di-soric GmbH & Co. KG
 Steinbeisstraße 6
 DE-73660 Urbach
 Germany
 Tel: +49 (0) 7181/9879-0
 info@di-soric.com · www.di-soric.com

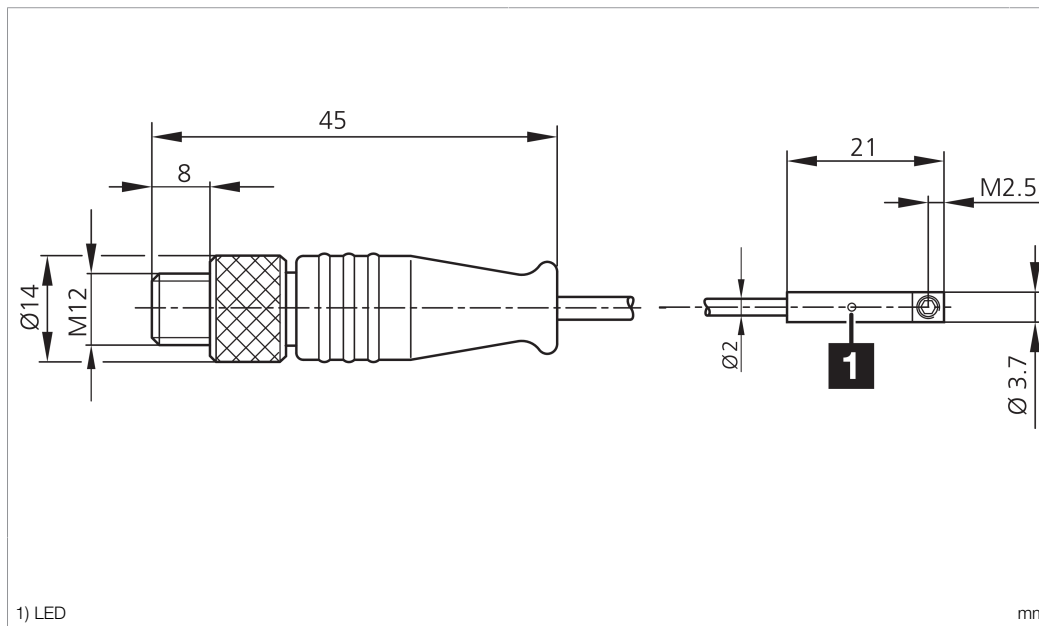

BK : 黑色
 BN : 棕色
 BU : 蓝色

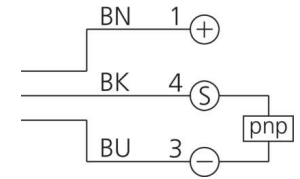

技术数据

装配

工作电压

开关输出端

空载电流 (最大)

外壳材料

工作环境温度

防护等级

连接

+20°C, 24 V DC

C 型槽

10 ... 30 V DC

pnp, 100 mA, NO

11 mA

不锈钢, 塑料, V2A 1.4301 / AISI 304

-20 ... +70 °C

IP 67

电缆/插头, 0.3 m, M12, 3 针

版本 24.10.22, 保留变更权



安全提示



一般安全提示

警告！没有符合 2006/42/EU 和 EN 61496-1 /-2 标准的安全结构件！不得用于人身安全保护！不遵守规定会导致死亡或重伤危险！仅按规定使用！

