

213349
OGWSD-70G3-T3
Frame light barrier

- IO-Link
- Frame structure
- Robust metal housing
- Baffle protection at the optics
- Cross bar, removable
- High resolution
- Short response time
- Potentiometer for adjustment
- Operating principle: dynamic or static
- 4 operating modes as an IO-Link parameter

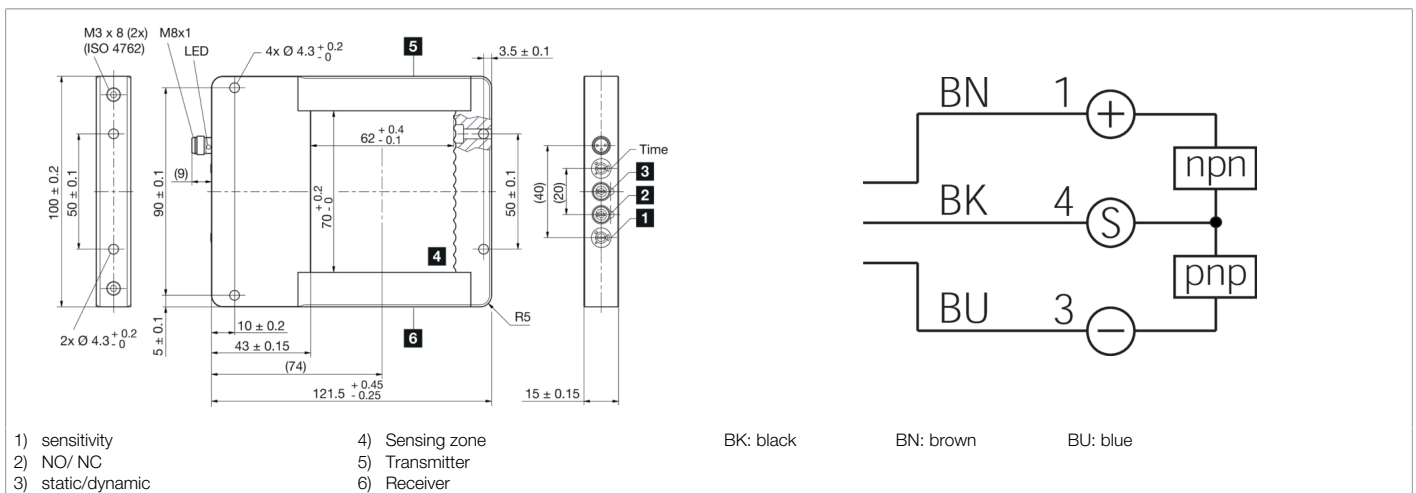

Function											

Technical data (typ.)	+20°C, 24 V DC
Service voltage	18 ... 30 V DC
No-load current (max.)	40 mA
Inverse polarity protection	Yes
Short-circuit protection	Yes
Housing dimensions	121.5 x 100 x 15 mm
Housing material	Aluminum (Black, Anodized)
Material	Plastic (Window)
Weight	210 g
Protection class	III, operation on protective low voltage
Approvals	UL
Operating principle	Optical
Evaluation	Switching, Dynamic/static switchable
Operating modes	Static, Dynamic, Shadowing
Switching output	Push-pull, 100 mA, NO/NC, switchable
Voltage drop (max.)	2 V
Interface	<ul style="list-style-type: none"> ■ IO-Link V1.1.3, COM2 (Smart Sensor Profile) ■ 2nd Edition V1.1 SSP 4.1.1
Pulse stretching	0 ... 150 ms adjustable
Light source	LED
Color	Infrared
Detection range	70 x 62 mm
Resolution	Ø 2.0 mm (static), Ø 1.5 mm (dynamic)



213349
OGWSD-70G3-T3
Frame light barrier

Technical data (typ.)	+20°C, 24 V DC
Sensitivity adjustment	Potentiometer
Display	LED yellow - Switching output
Response time	0.05 ms
Release time	0.05 ... 10000 ms
Ambient temperature during operation	-10 ... +60 °C
Protection type	IP 67
Connection	Connector, M8, 3-pin
Connection cable	TK ...
More information / accessories	https://www.di-soric.com/213349