



212978

OH21-80NS-2C

Retroreflective diffuse sensors with background suppression

- Miniature design
- Mounting element made of metal
- High switching frequency
- Ideal background suppression
- Scanning range preset

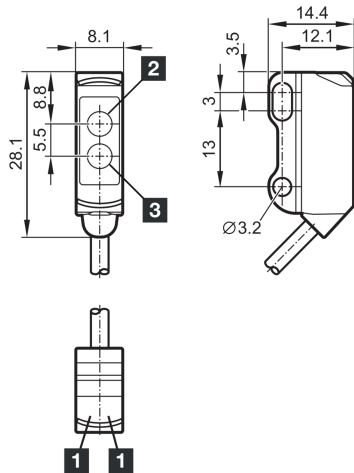

1) LED
2) Receiver

3) Transmitter

BK: black

BN: brown

BU: blue

Function



Technical data (typ.)

+20°C, 24 V DC

Service voltage	10 ... 30 V DC
No-load current (max.)	20 mA
Inverse polarity protection	Yes
Short-circuit protection	Yes
Housing dimensions	28.1 x 8.1 x 14.4 mm
Housing length	8.1 mm
Housing height	28.1 mm
Housing width	14.4 mm
Housing material	Stainless steel / Plastic
Material of cable	PVC
Material	Plastic (Window / optics)
Weight	37 g
Protection class	III, operation on protective low voltage
Approvals	UL
Operating principle	Diffuse sensor with background suppression
Evaluation	digital
Design	Cuboid design
Switching output	npn, 100 mA, NO
Voltage drop (max.)	2.5 V



212978

OH21-80NS-2C

Retroreflective diffuse sensors with background suppression

Technical data (typ.)	+20°C, 24 V DC
Light source	LED (Clocked)
Color	red
Wavelength	633 nm
Background suppression	Yes
Light spot size	> Ø 4 mm
Scanning range	1 ... 80 mm
Standardized measuring plate	200 x 200 mm (white)
Sensitivity adjustment	no setting elements
Display	LED Green - Status, yellow - Switching output
Switching frequency	1000 Hz
Ambient temperature during operation	-25 ... +60 °C
Protection type	IP 65 / IP 67
Connection	Cable, 2.0 m, 3-pin
More information / accessories	https://www.di-soric.com/212978