

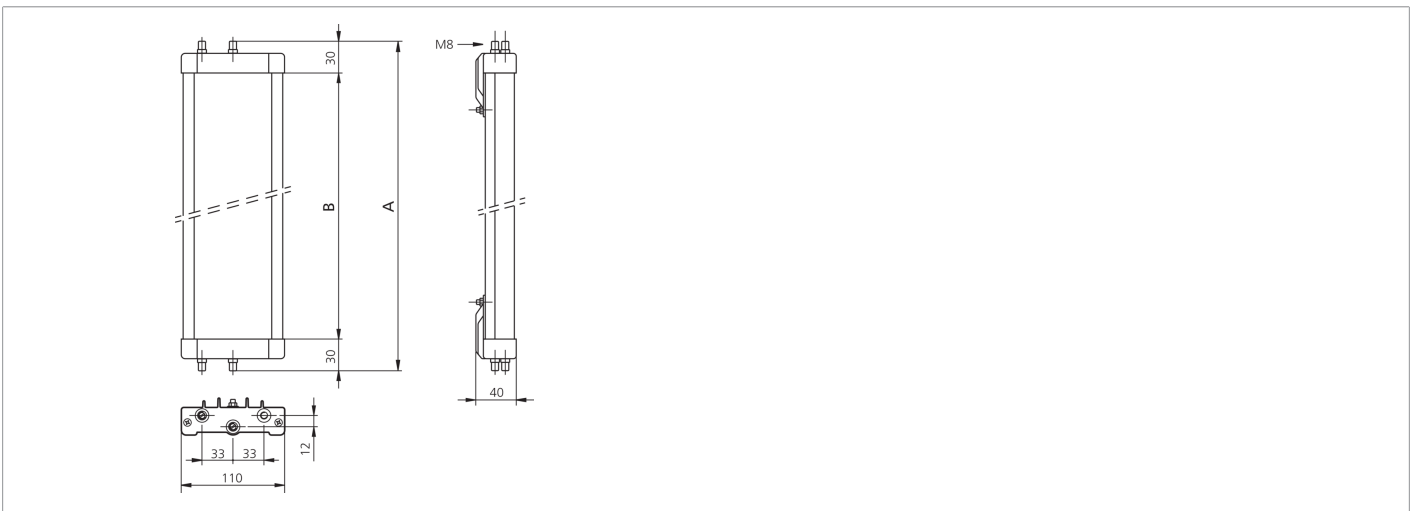

**208143**  
**SP 700 S**  
**Deflection mirrors**

- Not more than one safety light curtain / grid necessary
- For the realization of circumferential protective fields with up to 4 sides
- Adjustable angle alignment using two brackets supplied
- Special models with mirrors that have a shatter protection film are available on request
- Optical power reduction factor 15% for each mirror
- Extruded aluminum section bar



**Technical data (typ.)**

Total height (A)	945 mm
Housing material	Aluminum rod profile (Epoxy powder coating) / Plastic
Deflection mirror height (B)	885 mm
Operating principle	Deflection mirrors
To be used for	760 mm protective field height
Design	freely adjustable
Scope of delivery	Assembly instructions, 2 adjustable fixing brackets, Fixing material
Absorption factor	15 %
Ambient temperature during operation	-10 ... +55 °C (Mirror)

**More information / accessories**

<https://www.di-soric.com/208143>