



204237

LHT 81 M 400 G6L-IBS

Laser diffuse sensor with background suppression

- Mechanical background suppression
- Vibration-safe 6-turn adjustment for finest adjustment
- Red-light laser, with small laser spot
- Switching output and alarm output
- Push-pull pnp + npn
- High resolution, switching accuracy, switching frequency
- Functional reserve indicator and contamination indicator
- Robust metal housing

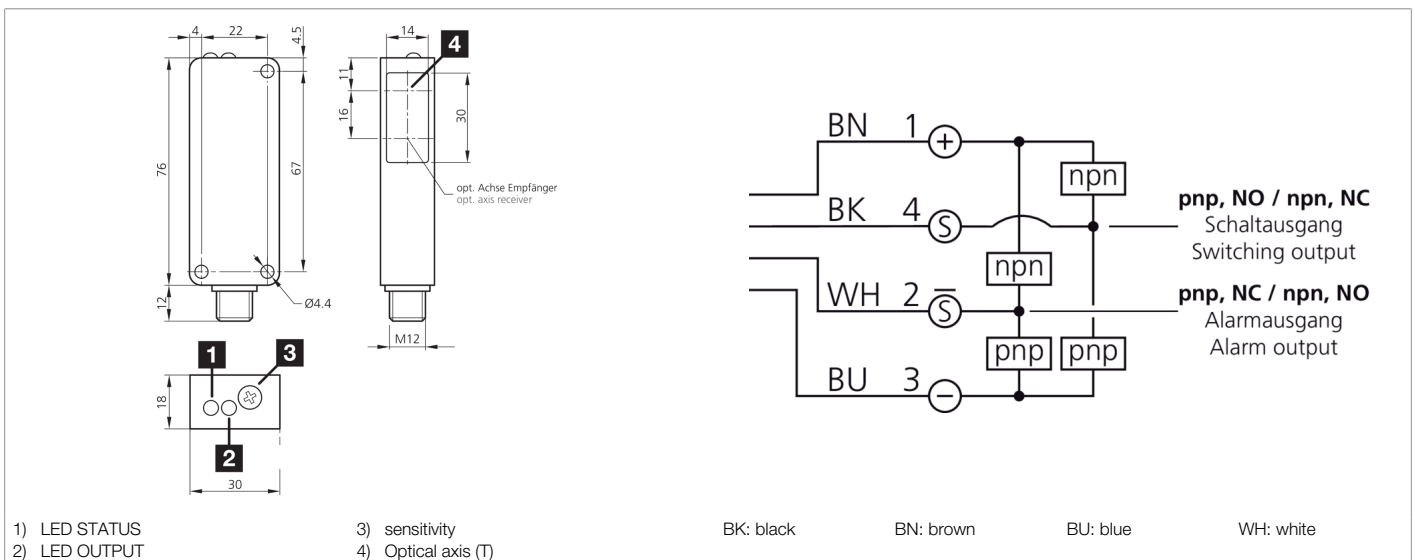

Function											

Technical data (typ.)	+20°C, 24 V DC
Service voltage	10 ... 35 V DC
No-load current (max.)	35 mA
Insulation voltage endurance	500 V
Housing dimensions	76 x 30 x 18 mm
Housing length	30 mm
Housing height	76 mm
Housing width	18 mm
Housing material	Die-cast zinc (Black, painted)
Material	Polycarbonate (Window)
Protection class	III, operation on protective low voltage
Operating principle	Diffuse sensor with background suppression
Evaluation	digital
Design	Cuboid design
Switching output	Push-pull, 200 mA, NO switching output, NC alarm output
Light source	Laser
Laser class	2 (IEC 60825-1)
Color	red
Wavelength	650 nm
Modulation	Clocked

 **204237****LHT 81 M 400 G6L-IBS****Laser diffuse sensor with background suppression**

<b>Technical data (typ.)</b>	<b>+20°C, 24 V DC</b>
Background suppression	Yes
Ambient light immunity	5 kLx
Switching distance	400 to 800 mm as diffuse sensor
Scanning range	40 ... 400 mm
Switching hysteresis (max.)	1 %
Sensitivity adjustment	Potentiometer (6-turn)
Switching frequency	1000 Hz
Ambient temperature during operation	-20 ... +60 °C
Protection type	IP 67
Connection	Connector, M12, 4-pin
Connection cable	VK ...
<b>More information / accessories</b>	<b><a href="https://www.di-soric.com/204237">https://www.di-soric.com/204237</a></b>