

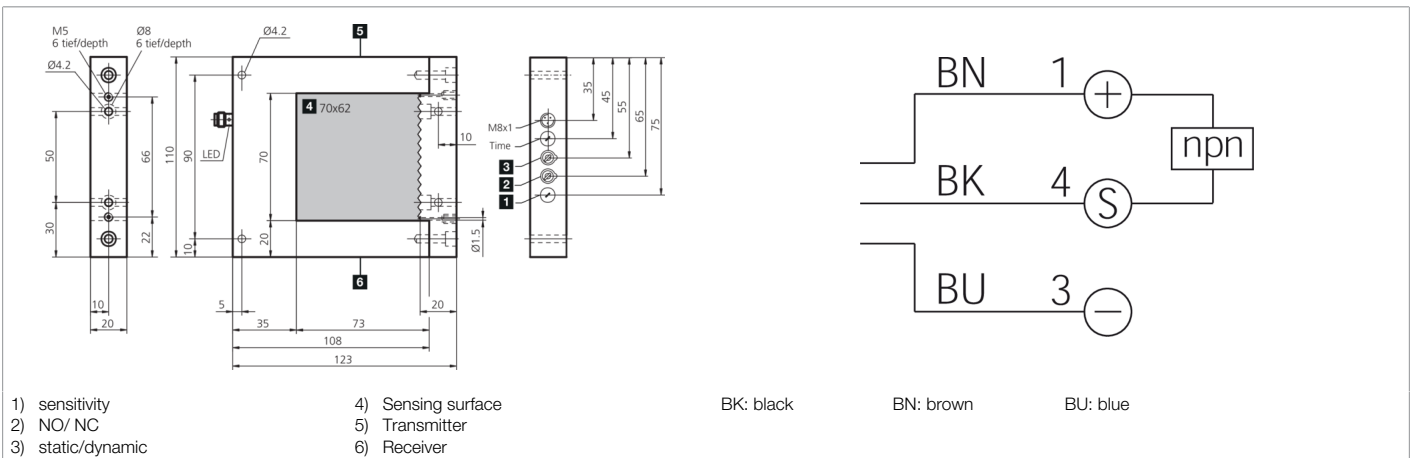

202237
OGWSD 70 N3K-TSSL
Frame light barrier

- Baffle protection at the optics
- Metal potentiometer
- Cross bar, removable
- Air nozzle for the optics
- NO/NC, switchable
- Variable operating principle: dynamic or static
- Sensitivity adjustment
- Pulse stretching adjustable
- High resolution
- Short response time



Function									

Technical data (typ.)	+20°C, 24 V DC
Service voltage	18 ... 35 V DC
No-load current (max.)	30 mA
Insulation voltage endurance	500 V
Housing material	Aluminum (Black, Anodized)
Protection class	III, operation on protective low voltage
Operating principle	Optical
Evaluation	digital, Dynamic/static switchable
Switching output	npn, 200 mA, NO/NC, switchable
Voltage drop (max.)	2.5 V
Pulse stretching	0.1 ... 150 ms adjustable
Light source	LED
Color	Infrared
Wavelength	940 nm
Modulation	Clocked
Ambient light immunity	20 kLx
Detection range	70 x 62 mm
Resolution	Ø 1.5 mm (dynamic), Ø 2.0 mm (static)
Sensitivity adjustment	Potentiometer
Response time	0.10 ms
Release time	0.10 ... 150 ms
Ambient temperature during operation	0 ... +60 °C
Protection type	IP 67
Connection	Connector, M8, 3-pin



202237

OGWSD 70 N3K-TSSL

Frame light barrier

Technical data (typ.)

+20°C, 24 V DC

Connection cable

TK ...

More information / accessories

<https://www.di-soric.com/202237>