

BEK 1-P7-G0TI-IBS

Spotbeleuchtung
Spotlight
Éclairages par spot

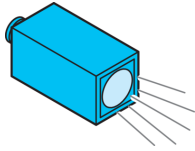

di-soric GmbH & Co. KG
Steinbeisstraße 6
DE-73660 Urbach
Germany
Tel: +49 (0) 7181/9879-0
info@di-soric.com · www.di-soric.com

207477

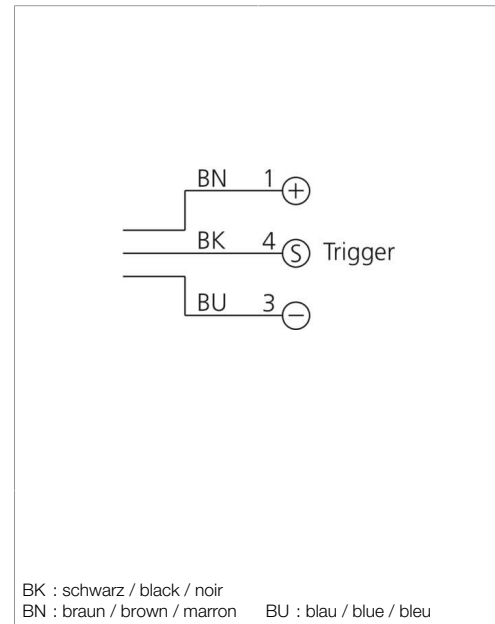
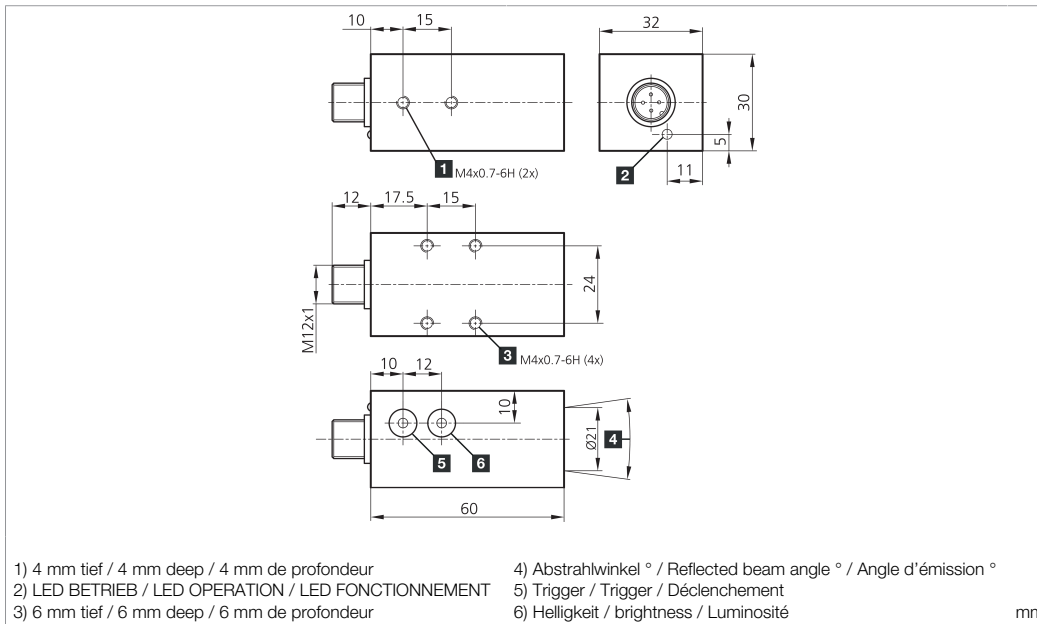

Technische Daten	Technical data	Caractéristiques techniques	+20°C, 24 V DC
Abstrahlwinkel FWHM	Deflection angle FWHM	Angle d'émission FWHM	7°
Betriebsspannung	Service voltage	Tension de service	10 ... 35 V DC (Supply Class 2)
Leistung	Power	Puissance	2,5 W / 24 V DC / 2,5 W / 24 V DC / 2,5 W / 24 V DC
Umgebungstemperatur Betrieb	Ambient temperature during operation	Température ambiante de fonctionnement	0 ... +50 °C
Schutzart	Protection type	Indice de protection	IP 67
Risikogruppe (DIN EN 62471)	Risk group (DIN EN 62471)	Groupe de risque (DIN EN 62471)	Risikogruppe 1 / Risk group 1 / Groupe de risque 1
Schutzklasse	Protection class	Classe de protection	III, Betrieb an Schutzkleinspannung / III, operation on protective low voltage / III, utilisation en très basse tension de sécurité

Stand 16.07.24, Änderungen vorbehalten
As of 07/16/24, subject to change
État 16.07.24, sous réserve de modifications

Enclosure Type 1 Supply Class 2
NFPA 79 Applications only. For adapters providing field wiring means refer to product information or customer support.

Sicherheitshinweise	Safety instructions	Consignes de sécurité
<p>Allgemeiner Sicherheitshinweis WARNUNG! Kein Sicherheitsbauteil gemäß 2006/42/EG und EN 61496-1 /-2! Darf nicht zum Personenschutz eingesetzt werden! Nichtbeachtung kann zu Tod oder schwersten Verletzungen führen! Nur bestimmungsgemäß verwenden!</p>	<p>General safety notice WARNING! Not a safety component pursuant to 2006/42/EG and EN 61496-1/-2! May not be used for personal protection! Non-compliance can lead to death or serious injuries! Only use as directed!</p>	<p>Consigne de sécurité générale AVERTISSEMENT ! Ce produit n'est pas un composant de sécurité au sens des réglementations 2006/42/CE et NF EN 61496-1/-2 ! Ne pas l'utiliser pour la protection des personnes ! Le non-respect de cette consigne peut entraîner la mort ou des blessures graves ! N'utiliser le produit que selon son utilisation conforme !</p>

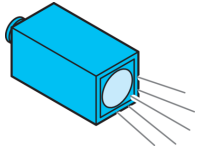

di-soric GmbH & Co. KG
 Steinbeisstraße 6
 DE-73660 Urbach
 Germany
 Tel: +49 (0) 7181/9879-0
 info@di-soric.com · www.di-soric.com

207477

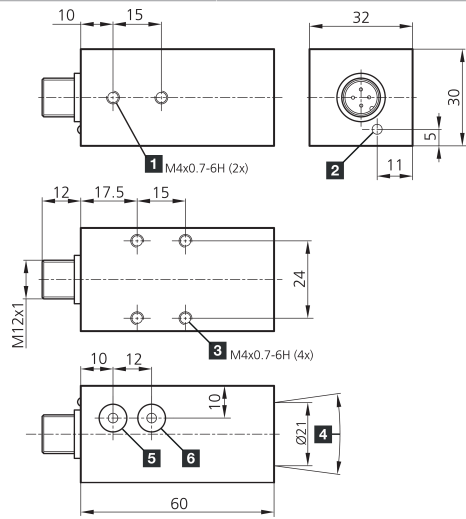

- 1) 4 mm 深
- 2) 工作 LED
- 3) 6 mm 深
- 4) 发射角 °
- 5) 触发器
- 6) 亮度

mm

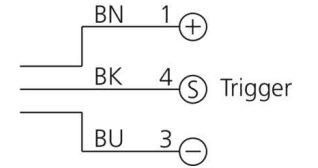

BK : 黑色
 BN : 棕色

BU : 蓝色

技术数据

发射角 FWHM

工作电压

功率

工作环境温度

防护等级

风险组 (DIN EN 62471)

防护等级

+20°C, 24 V DC

7°

10 ... 35 V DC (Supply Class 2)

2.5 W / 24 V DC

0 ... +50 °C

IP 67

风险组 1

III, 在安全特低电压下工作

版本 24.07.16, 保留变更权



Enclosure Type 1 Supply Class 2
 NFPA 79 Applications only. For ad-
 apters providing field wiring me-
 ans refer to product information or
 customer support.

安全提示



一般安全提示

警告！没有符合 2006/42/EU 和 EN 61496-1 /-2 标准的安全结构件！不得用于人身安全保护！不遵守规定会导致死亡或重伤危险！仅按规定使用！

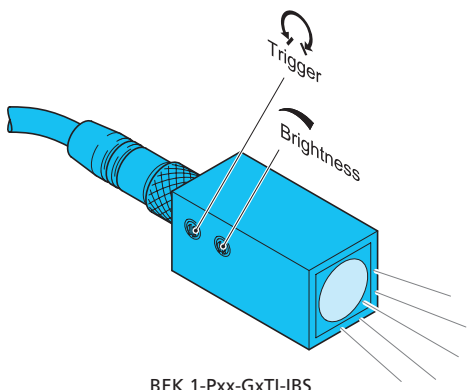

BEK 1-Pxx-GxTI-IBS

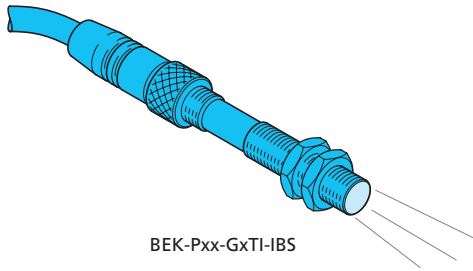



















BEK-Pxx-GxTI-IBS

Punktbeleuchtung

Spot light

Projecteur

 <p>Nicht dauerhaft in den Lichtstrahl blicken!</p>	 <p>Do not look into the light beam for a prolonged period of time!</p>	 <p>Ne pas regarder le rayon lumineux pendant une période de temps prolongée!</p>
 <p>Diese Beleuchtung erzeugt eine sichtbare oder unsichtbare Strahlung, welche bei dauerhafter Einwirkung schädlich sein kann!</p>	 <p>This light produces radiation which may or may not be visible and prolonged exposure may be harmful!</p>	 <p>Cette lumière produit des radiations qui pourraient ou ne pourraient pas être visibles et une exposition prolongée peut être nuisible!</p>
 <p>Wärme Konvektion gewährleisten!</p> <p>Die Erwärmung der Beleuchtung hat einen direkten Einfluss auf die Alterung/Lebensdauer der Beleuchtungs-LEDs! Je höher die Temperatur, desto stärker die Alterung.</p>	 <p>Ensure heat convection!</p> <p>The heating of the light has a direct impact on the ageing/lifetime of the light LEDs! The higher the temperature, the faster the ageing process.</p>	 <p>Protéger de l'émission de chaleur!</p> <p>La chaleur émise par la lumière a un effet direct sur le vieillissement/la durée de vie des LED! Plus la température s'élève, plus rapide est le processus de vieillissement.s</p>
<p>Je nach Funktionsumfang der Beleuchtung hat der Anwender die Möglichkeit, einer frühzeitigen Alterung der Beleuchtungs-LED wie folgt entgegenzuwirken:</p> <p>Depending on the functionality of the light LEDs, the user has the possibility to counteract premature aging as follows:</p> <p>Précautions à prendre pour éviter le vieillissement prématuré des LED :</p>		
 <ul style="list-style-type: none"> - Beleuchtung nicht abdecken - Beleuchtungsintensität an die Applikation anpassen (überschüssige Lichtstärke vermeiden) - Dauerlicht reduzieren/vermeiden (Triggerfunktion nutzen) - Beleuchtung bei längerer Nichtnutzung abschalten 	 <ul style="list-style-type: none"> - Do not cover the light - Adapt the light intensity to the application (avoid excessive light intensity) - Reduce/avoid continuous light (use trigger function) - Switch off light when it is not being used for longer periods of time 	 <ul style="list-style-type: none"> - Ne pas couvrir la lumière - Adapter l'intensité lumineuse en fonction de la nécessité de l'application (éviter l'excès d'intensité lumineuse) - Réduire/éviter l'éclairage continu (utiliser la fonction de déclenchement) - Éteindre l'éclairage lorsqu'il n'est pas utilisé pendant de longues périodes
 <p>Betriebswärme folgendermaßen abführen:</p> <ul style="list-style-type: none"> - Montage an eine kühlende Fläche (Maschinenkörper) - Montage an einen externen Kühlkörper 	 <p>Dissipate operating heat as follows:</p> <ul style="list-style-type: none"> - Install on a cool surface (machine structure) - Install on an external cooling element 	 <p>Dissiper la chaleur d'émission comme suit:</p> <ul style="list-style-type: none"> - Installer sur une surface froide (structure de la machine) - Installer sur un élément refroidissant externe
 <p>Regelmäßige Reinigung!</p> <p>Starke Verschmutzung verhindert den Lichtaustritt und erhöht die Wärmeentwicklung.</p>	 <p>Clean on a regular basis!</p> <p>Heavy contamination prevents light emission and increases heat development.</p>	 <p>Nettoyer régulièrement</p> <p>L'encrassement entrave la bonne émission de l'éclairage et accroît l'émission de chaleur.</p>