

HS-S-15-400-V

Montagestange
 Mounting rod
 Tige de montage



di-soric GmbH & Co. KG
 Steinbeisstraße 6
 DE-73660 Urbach
 Germany
 Tel: +49 (0) 7181/9879-0
 info@di-soric.com · www.di-soric.com

209463

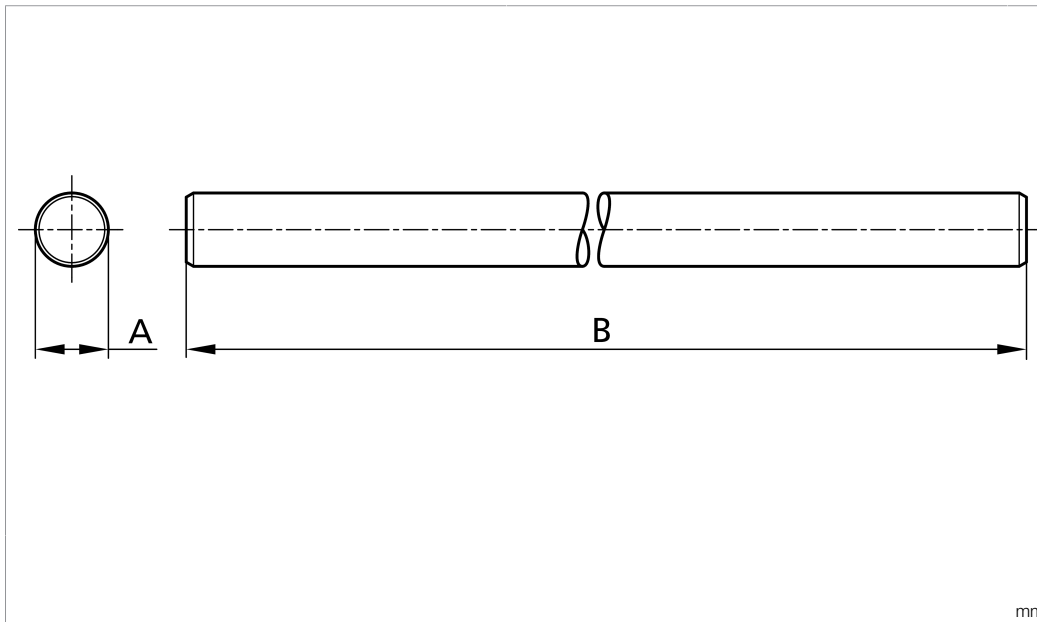

Technische Daten	Technical data	Caractéristiques techniques	+20°C
Produktserie	Product series	Gamme de produits	Z-UBT-KL-MS Montagesystem / Z-UBT-KL-MS Assembly system / Système de montage Z-UBT-KL-MS
Durchm. Montagezapfen/Bohrung	Diameter Mounting pin / boring	Diam. tourillon de montage/alésage	Ø 15 mm
Maß B	Dimension B	Dimension B	400 mm
Material	Material	Matériau	Edelstahl / Stainless steel / Acier inoxydable

Stand 16.07.24, Änderungen vorbehalten
 As of 07/16/24, subject to change
 État 16.07.24, sous réserve de modifications



HS-S-15-400-V

装配杆



di-soric GmbH & Co. KG
Steinbeisstraße 6
DE-73660 Urbach
Germany
Tel: +49 (0) 7181/9879-0
info@di-soric.com · www.di-soric.com

209463

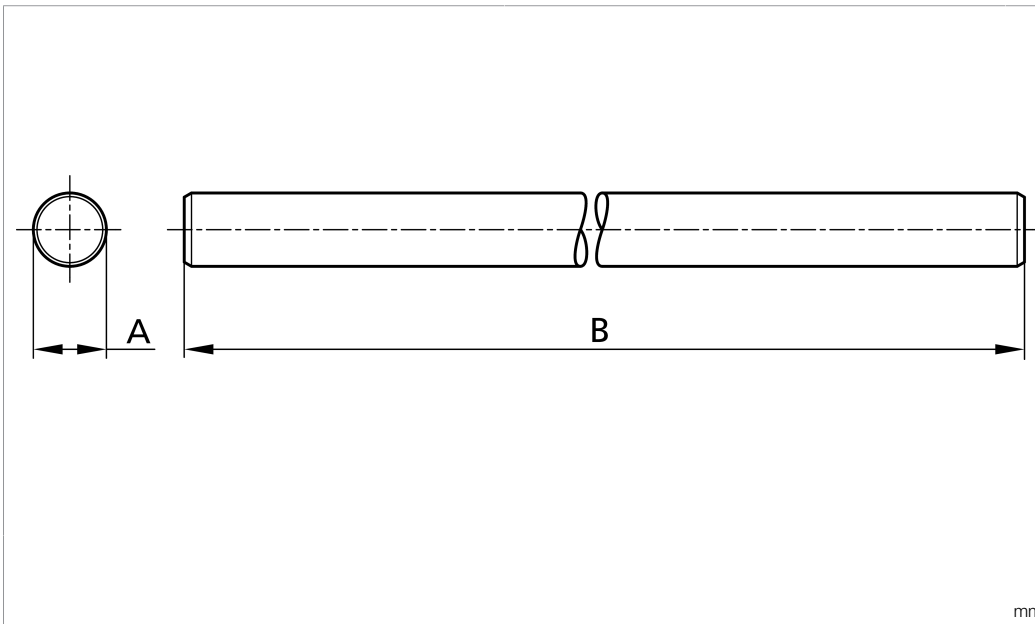

技术数据

产品系列

直径装配栓/钻孔

尺寸 B

材料

+20°C

Z-UBT-KL-MS 安装系统

Ø 15 mm

400 mm

不锈钢

版本 24.07.16, 保留变更权

Systemhalter Serie HS

Grundhalter Ø 12 mm

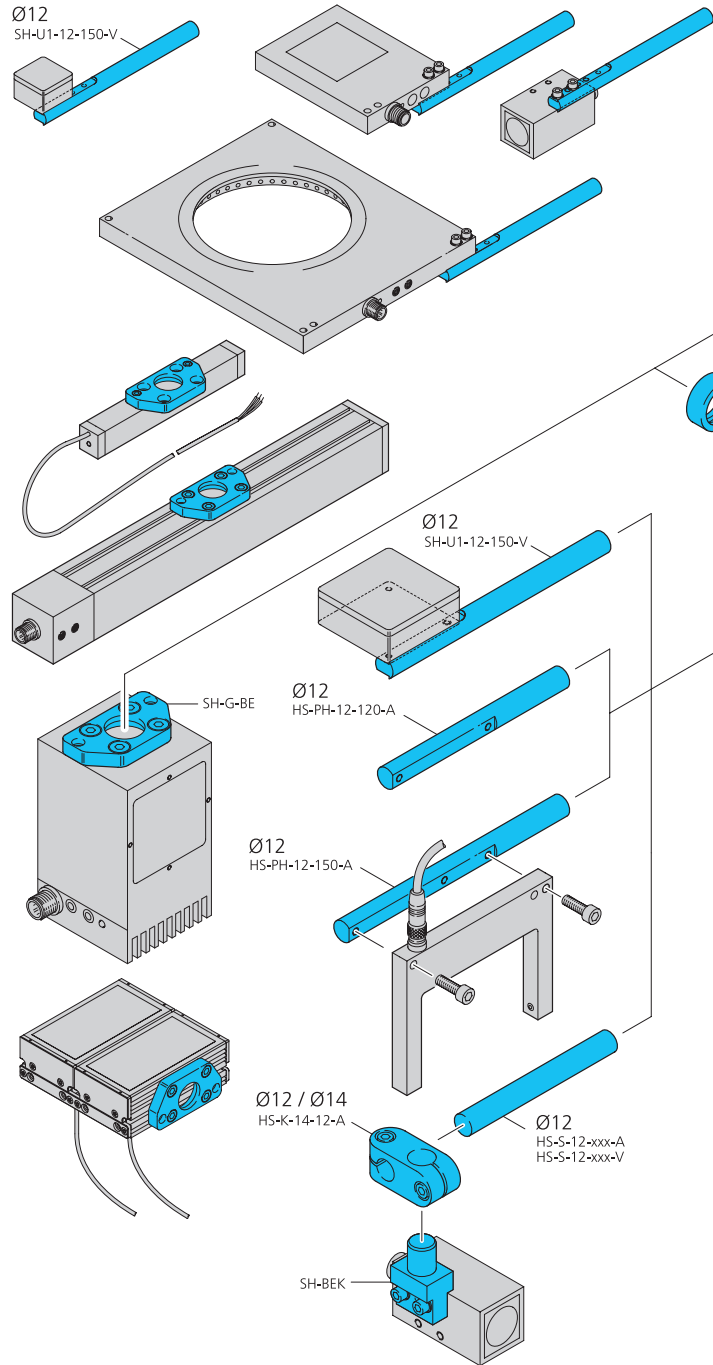

System holder series HS

Basic system holder Ø 12 mm

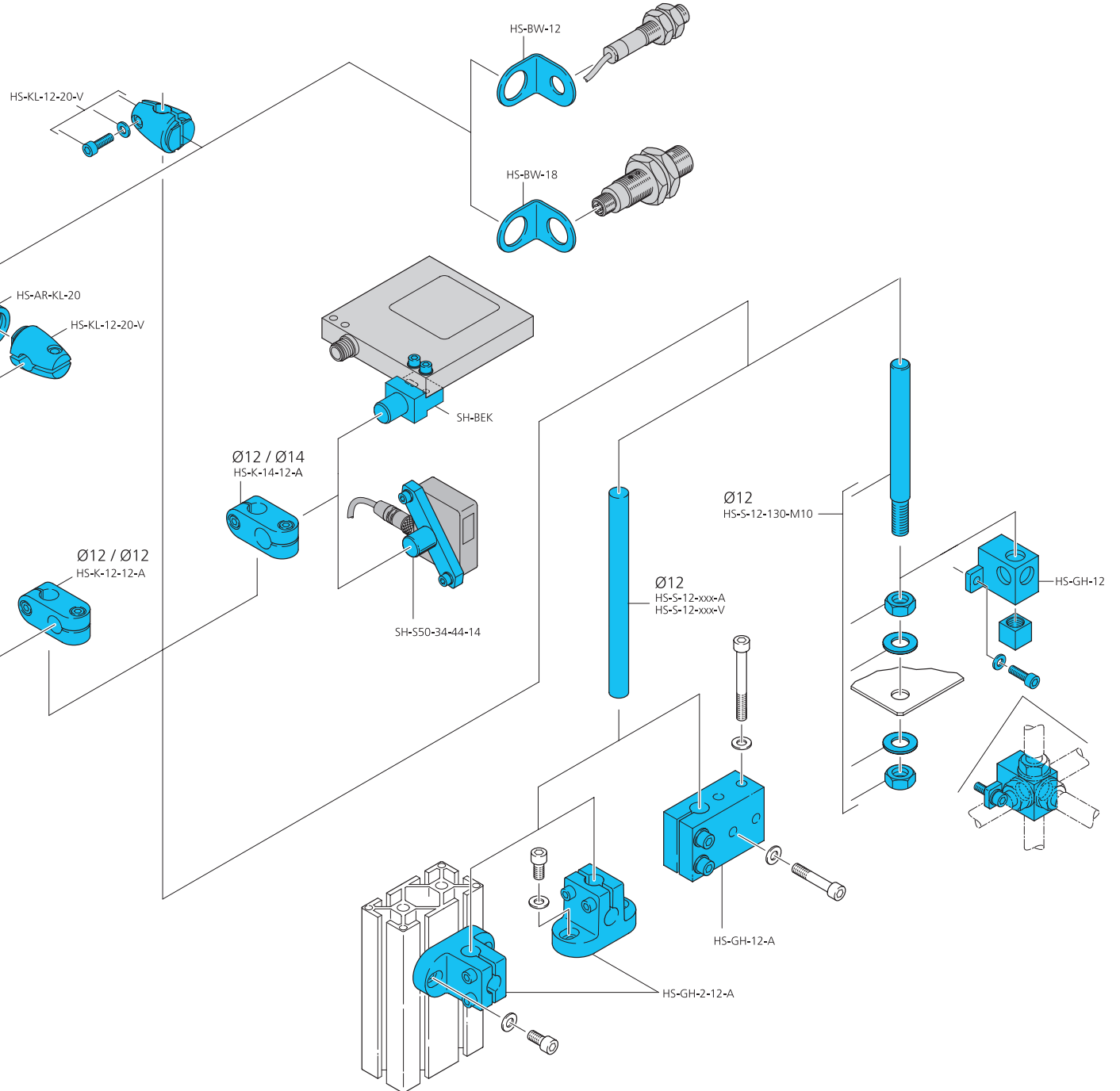

Systèmes de fixation Série HS

12 mm du support Ø de système de base

Systemhalter Serie HS

Grundhalter Ø 15 mm

System holder series HS

Basic system holder Ø 15 mm

Systèmes de fixation Série HS

15 mm du support Ø de système de base

